



**PUERTAS Y COMPLEMENTOS PARA
MUEBLES, ARMARIOS Y VESTIDORES**
*PORTAS E COMPLEMENTOS PARA MÓVEIS,
ROUPEIROS E CLOSETS*

7.1 Accesorios para interior de armario

- 7.05 Colgador abatible Hang
- 7.07 Tubos y soportes de colgar
- 7.13 Accesorios Moka
- 7.21 Accesorios Keeper
- 7.27 Accesorios Self

7.2 Perfiles y accesorios para puertas de madera

- 7.31 Información
- 7.33 Perfiles tirador enderezador Adige
- 7.34 Perfiles tirador enderezador Brenta
- 7.35 Perfiles tirador enderezador Free Face
- 7.37 Perfiles tirador enderezador Free Rapid
- 7.38 Perfiles tirador enderezador Rhodes
- 7.39 Perfiles tirador enderezador Sparta
- 7.40 Perfiles tirador enderezador Styl
- 7.40 Tiras guardapolvo para puertas correderas
- 7.41 Perfiles para cantos Face
- 7.42 Tensores para puertas

7.3 Puertas de aluminio para armario

- 7.45 Puertas Free
- 7.47 Perfiles Free

7.4 Estructuras modulares

- 7.51 Sistema Jagmet
- 7.53 Sistema Tram

7.5 Perfiles para puertas con marco de aluminio

- 7.61 Información perfiles Plus
- Puertas Plus de aluminio**
- 7.62 Perfiles Plus
 - 7.67 Accesorios para perfiles Plus
 - 7.70 Tiradores

7.1 Acessórios para interior de roupeiro

- 7.05 Varão basculante Hang
- 7.07 Varões e suportes para pendurar
- 7.13 Acessórios Moka
- 7.21 Acessórios Keeper
- 7.27 Acessórios Self

7.2 Perfis e acessórios para portas de madeira

- 7.31 Informação
- 7.33 Perfis puxador endireitador Adige
- 7.34 Perfis puxador endireitador Brenta
- 7.35 Perfis puxador endireitador Free Face
- 7.37 Perfis puxador endireitador Free Rapid
- 7.38 Perfis puxador endireitador Rhodes
- 7.39 Perfis puxador endireitador Sparta
- 7.40 Perfis puxador endireitador Styl
- 7.40 Fitas guarda-pó para portas de correr
- 7.41 Perfis para cantos Face
- 7.42 Esticadores para portas

7.3 Portas de alumínio para roupeiros

- 7.45 Portas Free
- 7.47 Perfis Free

7.4 Estruturas modulares

- 7.51 Sistema Jagmet
- 7.53 Sistema Tram

7.5 Perfis para portas com moldura de alumínio

- 7.61 Informação portas alumínio
- Portas Plus de alumínio**
- 7.62 Perfis Plus
 - 7.67 Acessórios para perfis Plus
 - 7.70 Puxadores

ACCESORIOS PARA INTERIOR DE ARMARIO

- 7.05 Colgador abatible Hang
- 7.07 Tubos y soportes de colgar
- 7.13 Accesorios Moka
- 7.21 Accesorios Keeper
- 7.27 Accesorios Self

ACESSÓRIOS PARA O INTERIOR DO ROUPEIRO

- 7.05 *Varão basculante Hang*
- 7.07 *Varões e suportes para pendurar*
- 7.13 *Acessórios Moka*
- 7.21 *Acessórios Keeper*
- 7.27 *Acessórios Self*





COLGADOR ABATIBLE HANG

VARÃO BASCULANTE HANG

Hang para armario

Varão basculante Hang

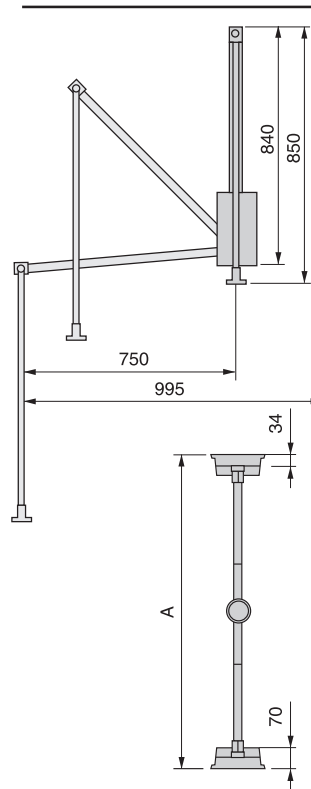

A	Cod.		
450-600	92837	11	1
600-830	92838	11	1
830-1.150	92839	11	1

Acero y plástico
Aço e plástico

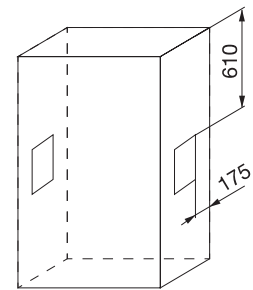

- Aplicable al sistema Tram utilizando Cod. 61082 25.
- Aplicável ao sistema Tram utilizando Cod. 61082 25.

Hang a pared

Hang de fixação à parede

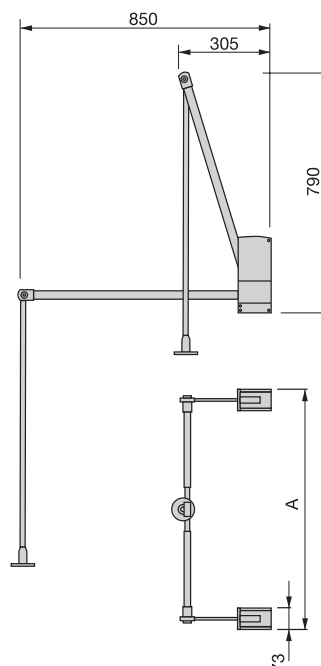

A	Cod.		
600-830	60378	11	1

Acero y plástico
Aço e plástico



- Montaje directo a pared.
- Montagem direta à parede.



Separador para Hang de armario

Separador para Hang de roupeiro



- Permite montar el Hang en el fondo del armario.
- Permite montar o Hang no fundo do roupeiro.

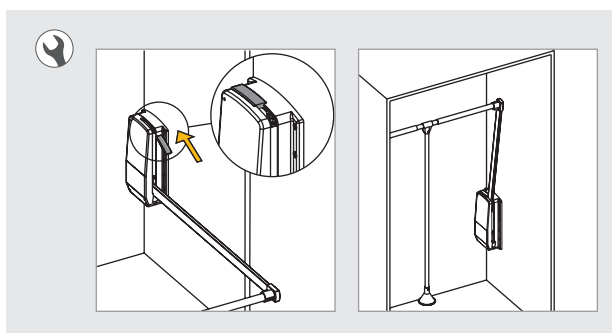

Cod. 



82854	25	2
-------	----	---

Plástico / Plástico

Suplemento lateral Hang

Distanciador lateral Hang



x 12

x 1

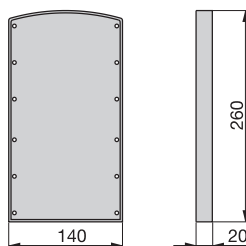

20

Cod. 



92803	25	2
-------	----	---

Plástico / Plástico



Para utilizar con puertas abisagradas o suplementar medidas de hueco de módulo.

Para utilizar com portas de abrir com dobradiças ou acrescentar medidas de espaço interior do módulo.

Accesorio Tram

Acessório Tram



x 2

x 4

x 4

x 4

x 8

x 4

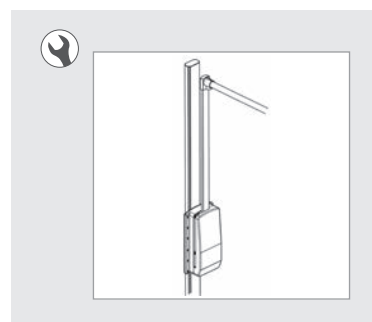

Cod. 



61082	25	1
-------	----	---

Acero y zamak
Aço e zamak

TUBOS Y SOPORTES DE COLGAR



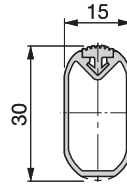

VARÕES E SUPORTES PARA PENDURAR

Tubo Silk con goma

Varão Silk com borracha



- Con goma de PVC coextruída para evitar el ruido de las perchas.
- Com borracha de PVC co-extruída para evitar o barulho dos varão trombone.





	Cod. 	
2,4 m	60721 62	24 m
4 m	60720 62	40 m
3 m	60722 62	

Aluminio y plástico
Aluminio e plástico

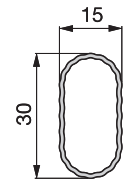
Tubo de aluminio

Varão de alumínio



	Cod. 	
2,4 m	62203 62	24 m
4 m	62202 62	40 m
2,93 m	62191 62	





Aluminio / Aluminio

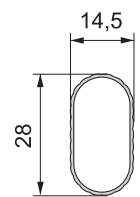

Tubo Zen

Varão Zen







	Cod. 	
4 m	70130 62	40 m
2,93 m	70131 62	

Aluminio / Aluminio

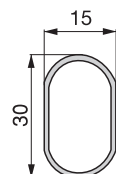
Tubo de acero

Varão de aço





	Cod. 	
2,4 m	70094 11	24 m
3 m	70099 11	30 m
3 m	80342 11	

Acero / Aço

Tubo aluminio Ø28

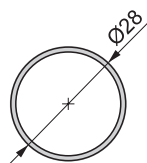
Varão de alumínio Ø28



	Cod. 		
2 m	70142	13 62	20 m
4 m	70141	13 62	40 m

Aluminio / Alumínio





Para calcular la medida de la barra restar 3mm a la medida de interejes de los soportes.

Para calcular a medida do varão de roupeiro deve-se adicionar 3mm à medida entre furos dos respectivos suportes.

Soporte lateral Ø28

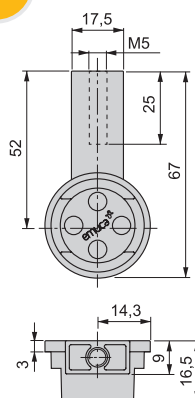
Suporte lateral Ø28



Cod. 		
79192	13 25	200



Zamak / Zamak

- Tornillo montaje M5 x 38 incluido.
- Parafuso de montagem M5 x 38 incluído.

Soporte central Ø28

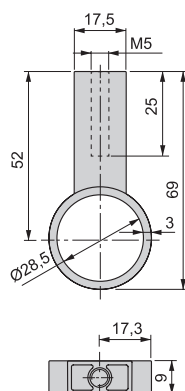
Suporte central Ø28



Cod. 		
79197	13 25	200

Zamak / Zamak

- Tornillo montaje M5 x 38 incluido.
- Parafuso de montagem M5 x 38 incluído.



Soporte lateral Silk

Suporte lateral Silk

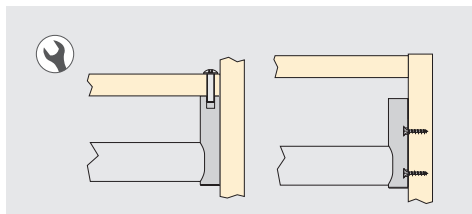
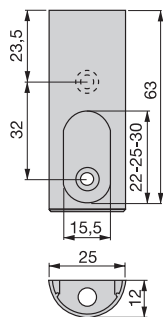

Cod. 



60075 25 100

Plástico / Plástico

- Tornillo montaje M6 x 40 incluido.
- Parafuso de montagem M6 x 40 incluido.

Soporte central Silk

Suporte central Silk

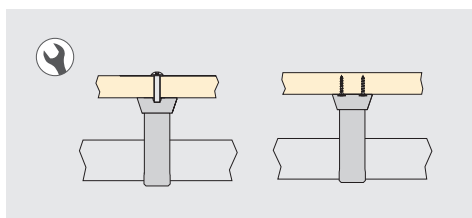
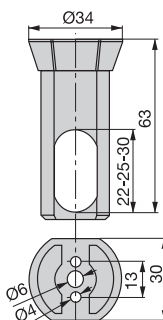

Cod. 



60078 25 100

Plástico / Plástico

- Tornillo montaje M6 x 40 incluido.
- Parafuso de montagem M6 x 40 incluido.

Soporte lateral Silk 2

Suporte lateral Silk 2



Para calcular la medida de la barra restar 7mm de la medida del hueco.

Para calcular a medida da barra subtrair 7mm à medida do espaço interior.

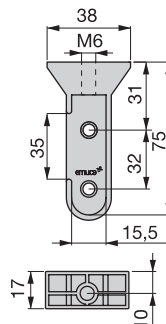

Mano / Mão

Cod. 



Derecha / Direita **60029** 25 100

Izquierda / Esquerda **60030** 25 100

Plástico / Plástico

- Tornillo montaje M6 x 40 incluido.
- Parafuso de montagem M6 x 40 incluido.

Soporte central Silk 2

Suporte central Silk 2

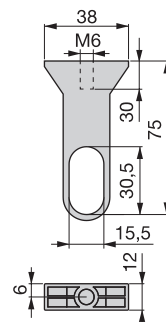

Cod. 



60031 25 100

Plástico / Plástico

- Tornillo montaje M6 x 40 incluido.
- Parafuso de montagem M6 x 40 incluido.

Soporte angular Silk 2

Suporte angular Silk 2

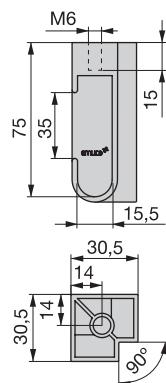

Cod. 



60032 25 100



Plástico / Plástico

- Tornillo montaje M6 x 40 incluido.
- Parafuso de montagem M6 x 40 incluido.

Soporte

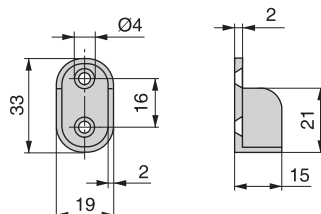
Soporte





Cod. 			
90168	07	25	500
Zamak / Zamak			

Soporte montaje directo

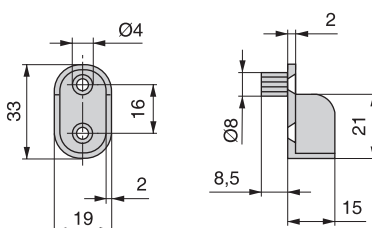
Soporte de montaje directa (com espigão)





Cod. 			
90167	07	500	
Zamak / Zamak			

Soporte

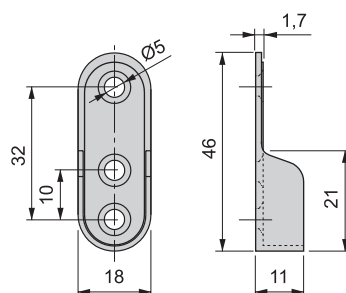
Soporte





Cod. 			
40070	07	500	
Acero / Aço			

Soporte

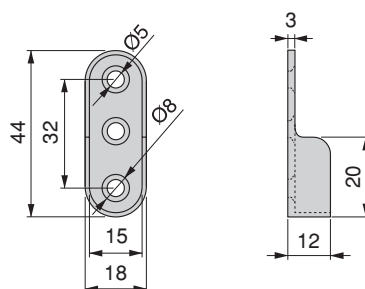
Soporte





Cod. 			
90723	07	500	
Zamak / Zamak			

Soporte

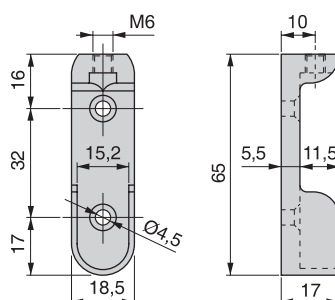
Soporte



Cod. 			
60474	07	25	200
Zamak / Zamak			

Soporte lateral

Soporte lateral

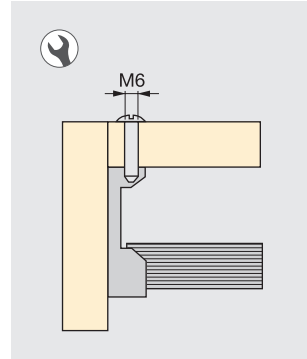
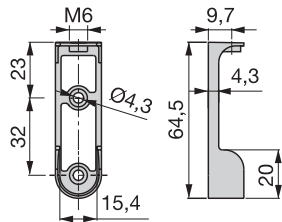

Cod. 



80469	07	25	250
-------	----	----	-----

Zamak / Zamak

Soporte central T

Soporte central T

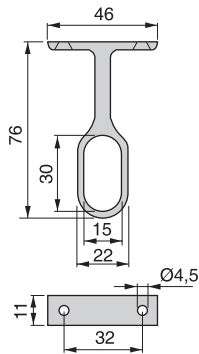

Cod. 



60026	07	25	300
-------	----	----	-----

Zamak / Zamak

Soporte central Equ

Soporte central Equ

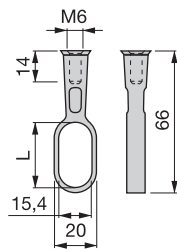

L

Cod. 



25	81202	07	-	500
30	81203	-	25	500

Zamak / Zamak

Base Equ para soporte central

Base Equ para soporte central

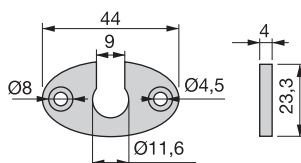

Cod. 



81204	25	500
-------	----	-----

Zamak / Zamak



 Consulta nuestra página web
Veja o nosso site
www.emuca.com

MOKA
wardrobe storage system

YouTube



www.emuca.com

ACCESORIOS MOKA



ACESSÓRIOS MOKA

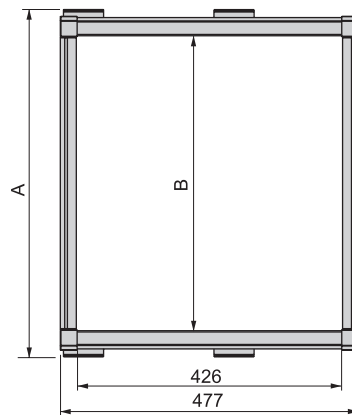
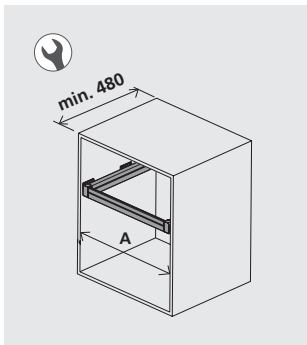
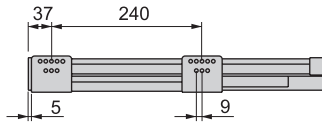

Estructura con guías Moka

Bastidor Moka com corrediças





A	B	Cod.		
564 - 614	484 - 534	69300	13	1
614 - 664	534 - 584	69299	13	1
664 - 714	584 - 634	69301	13	1
714 - 764	634 - 684	69306	13	1
764 - 814	684 - 734	69302	13	1
814 - 864	734 - 784	69307	13	1
864 - 914	784 - 834	69303	13	1
914 - 964	834 - 884	69308	13	1
964 - 1.014	884 - 934	69304	13	1
1.014 - 1.064	934 - 984	69309	13	1
1.064 - 1.114	984 - 1.034	69305	13	1

Aluminio y plástico / Alumínio e plástico

Cajón de alambre

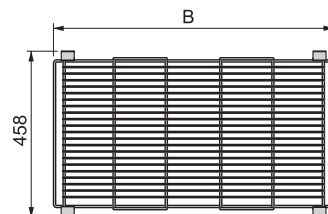
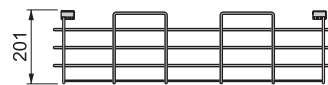
Gaveta de arame



B	Cod.		
475	69330	13	2
675	69331	13	2
775	69332	13	2

Acero / Aço

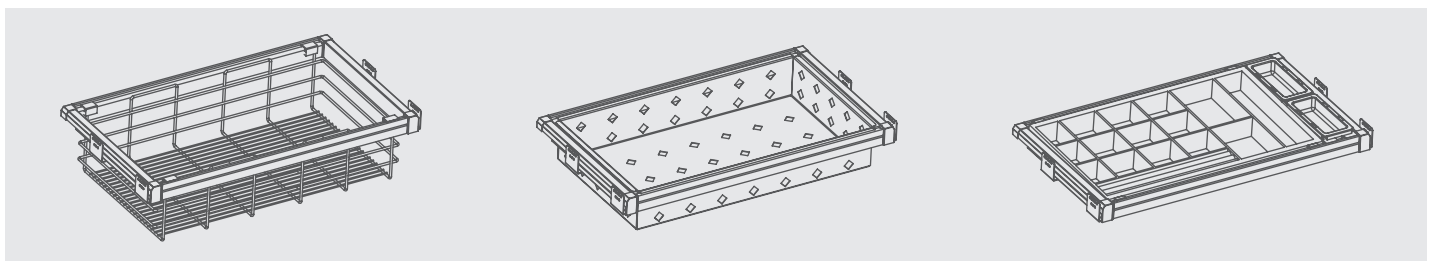

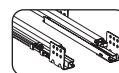



Guías ocultas de extracción total.
 Corrediças ocultas de extração total.

Cajón metálico

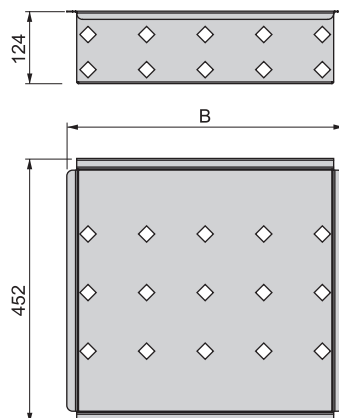
Gavetao metálico





B	Cod. 	
475	69320	13 1
675	69321	13 1
775	69322	13 1

Acero / Aço

Cajón zapatero

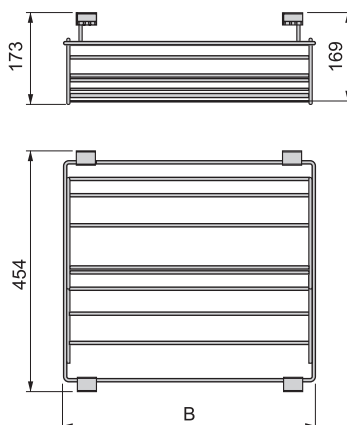
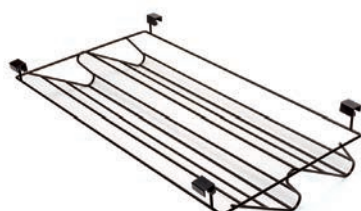
Cesto sapateira





B	Cod. 	
475	69370	13 2
675	69371	13 2
775	69372	13 2

Acero / Aço

Cajón organizador

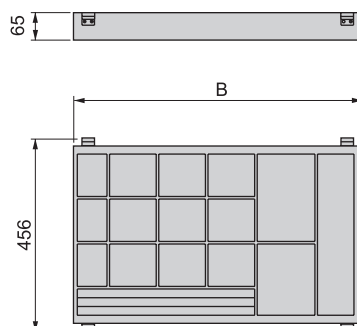
Gaveta organizadora



B	Cod. 	
483	69310	75 1
683	69311	75 1
783	69312	75 1

Madera y varios
 Madeira e vários

Cajón de madera

Gaveta de madeira

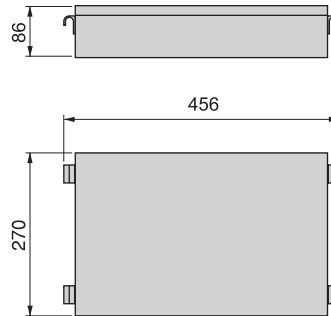

Cod.  

69350 49 1

Madera y varios
Madeira e vários



Cesto de ropa

Cesto de roupa

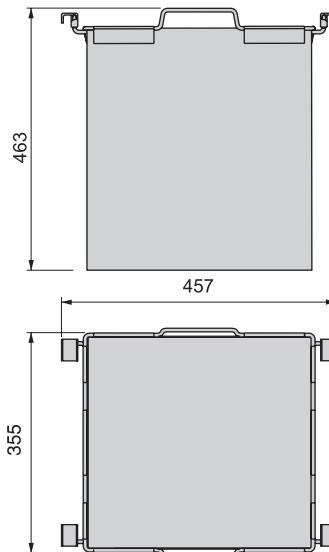

Cod.  

69342 13 1

Acero y tela
Aço e tecido

Juego de distanciadores (delantero y trasero)

Jogo de distanciadores (frontal e traseira)

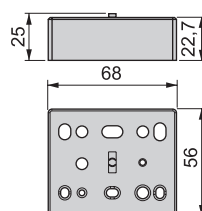

Cod.  

69399 43 1

Plástico / Plástico

- Tornillo recomendado Ø4x40.
- Parafuso recomendado Ø4x40.



Para utilizar con puertas abisagradas o suplementar medidas de hueco de módulo.

Para utilizar com portas de abrir com dobradiças ou acrescentar medidas de espaço interior do módulo.

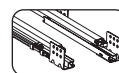

Guías ocultas de extracción total.
 Corrediças ocultas de extração total.

Bandeja auxiliar

Travessa auxiliar

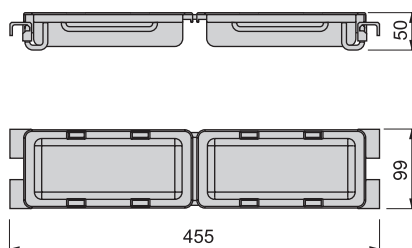

Cod. 



69396	13	1
-------	----	---

Aluminio y plástico
 Alumínio e plástico

Juego de 7 varillas pantalonero

Jogo de 7 varetas porta calças

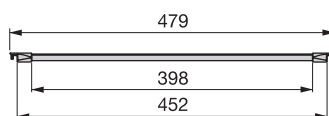
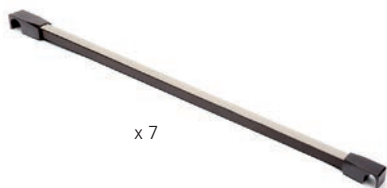

Cod. 



69340	13	1
-------	----	---

Aluminio y plástico
 Alumínio e plástico

Pinza de colgar

Mola de pendurar

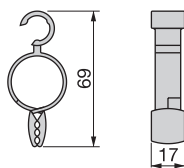

Cod. 



69341	43	10
-------	----	----



Plástico / Plástico

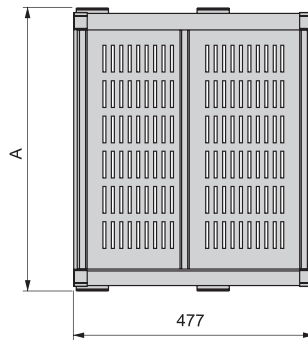
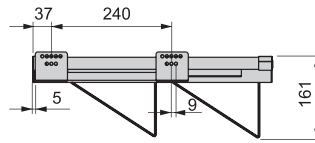

Zapatero con estructura

Sapateira com bastidor



A	Cod. 	
564 - 594	69360 13	1
764 - 794	69361 13	1
864 - 894	69362 13	1

Acero / Aço



Incluye bastidor con guías.
 Inclui bastidor com corredeiras.



Colgador extraíble

Cabide extraível

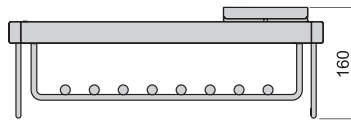
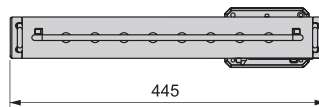

Cod. 

69387	13	1
--------------	----	---

Aluminio y plástico
 Alumínio e plástico

YouTube



Corbatero lateral extraíble

Porta gravatas lateral extraível

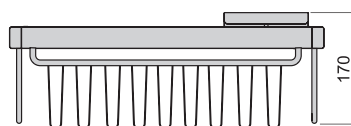
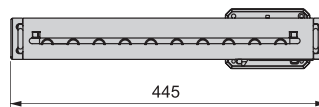

Cod. 

69388	13	1
--------------	----	---

Aluminio y plástico
 Alumínio e plástico

YouTube



- Fijación a ambos lados.
- Fixação a ambos lados.



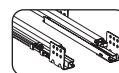



Guías ocultas de extracción total.
 Corrediças ocultas de extração total.

Pantalonero extraíble 8 varillas

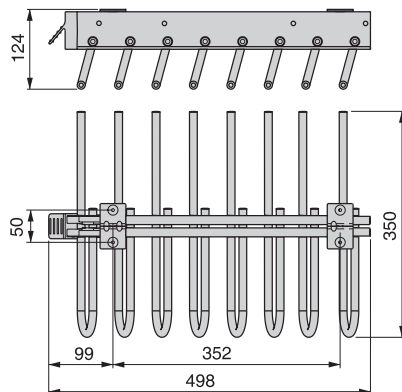
Porta calças extraível 8 varetas



- Guías de 450 mm de extracción total.
- Incorpora un tirador para facilitar la extracción.
- Incluye tornillos para montaje.
- Incluye gomas antideslizantes.
- Corrediças de 450 mm de extração total.
- Incorpora um puxador para facilitar a sua extração.
- Inclui os parafusos para a sua montagem.
- Inclui gomas antideslizantes.

Mano / Mão	Cod. 	
Izquierda / Esquerda	69128	13 1
Derecha / Direita	69234	13 1

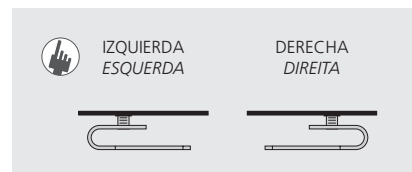

Acero y plástico
 Aço e plástico

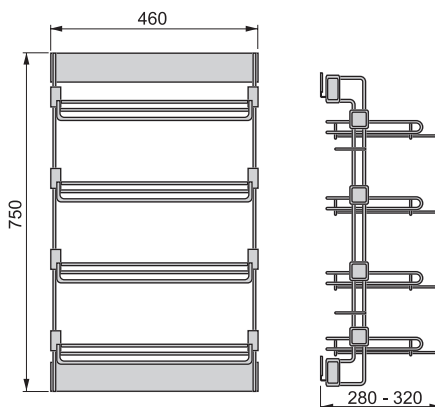

Zapatero lateral extraíble

Sapateira lateral extraível



Mano / Mão	Cod. 	
Izquierda / Esquerda	69384	13 1
Derecha / Direita	69385	13 1

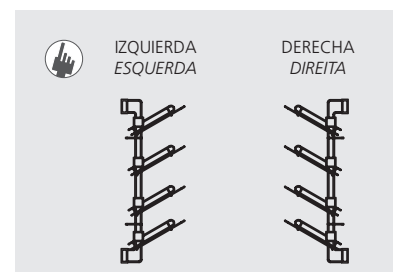

Acero y plástico
 Aço e plástico

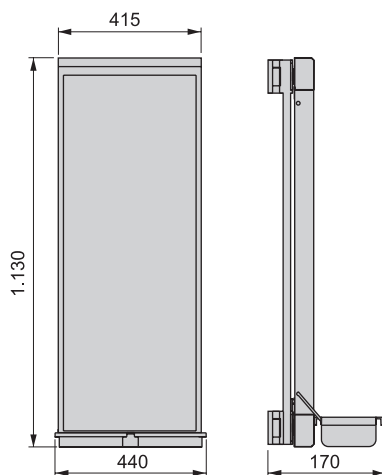

Especo extraíble

Espelho extraível



Cod. 	
69386	13 1



Acero y plástico
 Aço e plástico

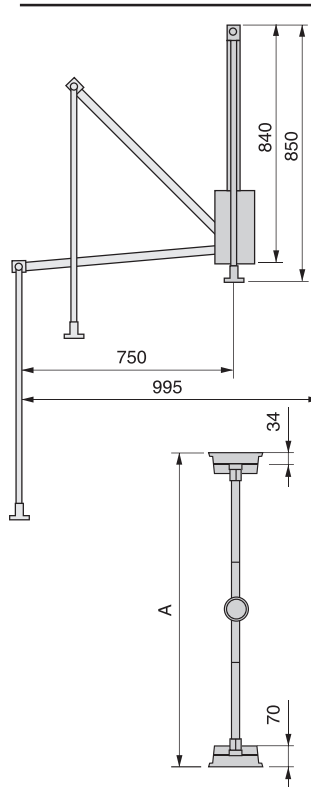

Hang para armario

Varão basculante Hang



A	Cod.		
450-600	92837	13	1
600-830	92838	13	1
830-1.150	92839	13	1

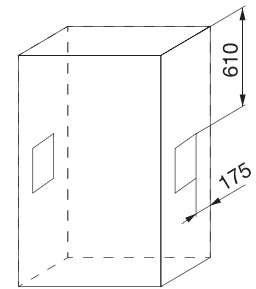

Acero y plástico
 Aço e plástico

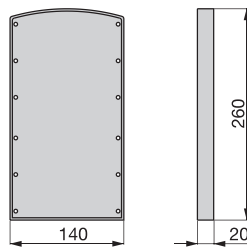

Suplemento lateral Hang

Distanciador lateral Hang



Cod.		
92803	13	2

Plástico / Plástico



Para utilizar con puertas abisagradas o suplementar medidas de hueco de módulo.

Para utilizar com portas de abrir com dobradiças ou acrescentar medidas de espaço interior do módulo.

YouTube





www.emuca.com

Tubo aluminio Ø28

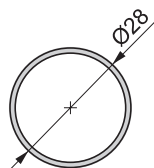
Varão de alumínio Ø28



L	Cod. 			
2 m	70142	13	62	20 m
4 m	70141	13	62	40 m

Aluminio / Alumínio



Para calcular la medida de la barra restar 3mm a la medida de interejos de los soportes.

Para calcular a medida do varão de roupeiro deve-se adicionar 3mm à medida entre furos dos respectivos suportes.

Soporte lateral Ø28

Suporte lateral Ø28

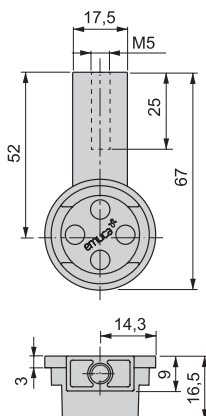

Cod. 			
79192	13	25	200

Zamak / Zamak

- Tornillo montaje M5 x 38 incluido.
- Parafuso de montagem M5 x 38 incluído.

Soporte central Ø28

Suporte central Ø28

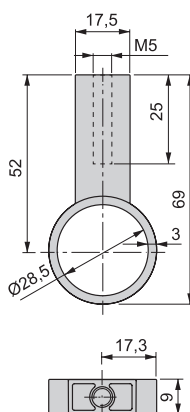

Cod. 			
79197	13	25	200

Zamak / Zamak

- Tornillo montaje M5 x 38 incluido.
- Parafuso de montagem M5 x 38 incluído.

ACCESORIOS KEEPER



ACESSÓRIOS KEEPER

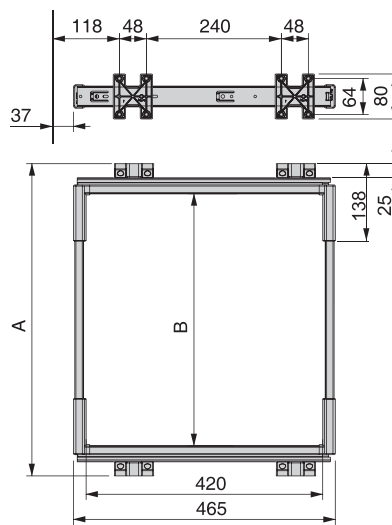

Guías

Corrediças



A	B	Cod. 	
555-710	448-609	79133	62 1
710-855	603-758	79134	62 1
855-1.000	748-893	79135	62 1
1.000-1.150	893-1.043	79136	62 1

Aluminio y plástico / Alumínio e plástico

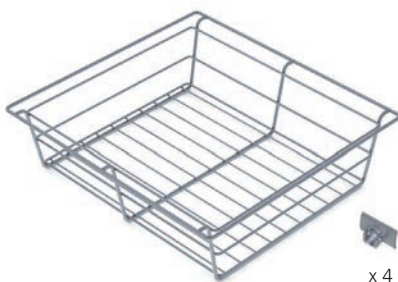

Cajón metálico

Gavetão metálico

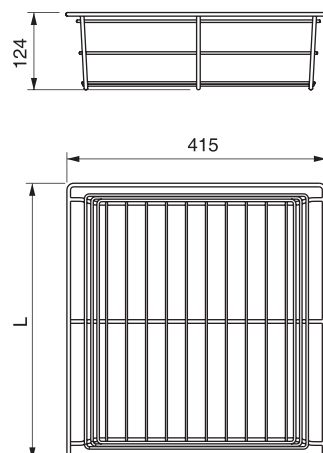

x 4



L	Cod. 	
443	79130	25 2
593	79193	25 2
743	79194	25 2

Acero / Aço

You Tube



www.emuca.com

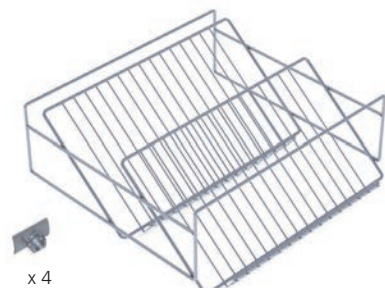

Zapatero auxiliar

Sapateira auxiliar

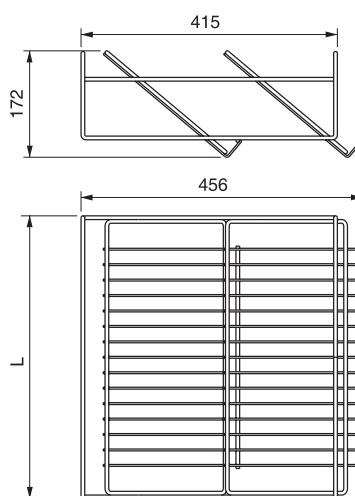

x 4





L	Cod. 	
458	79141	25 2
608	79195	25 2
758	79196	25 2

Acero / Aço

Cesto de ropa

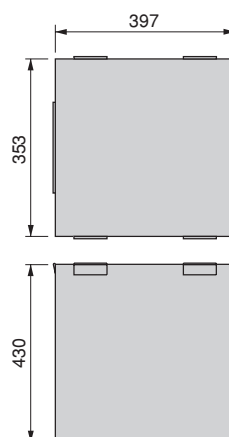
Cesto de roupa





Cod. 	
79143	25 1

Acero y tela
Aço e tecido

Bandeja

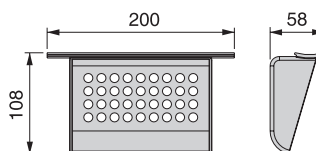
Bandeja



Cod. 	
79132	20 2

Plástico / Plástico



Juego de varillas para pantalonero

Jogo de varetas para porta calças



x 7





Cod. 	
79131	62 1

Aluminio y plástico
Alumínio e plástico

Pinza de colgar

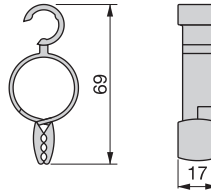
Mola de pendurar





Cod. 	
69153 21 10	
Plástico / Plástico	

Gancho para corbatero

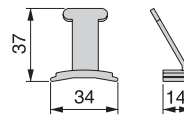
Gancho para porta gravatas





Cod. 	
79142 25 15	
Plástico / Plástico	

Bandeja lateral extraíble triple

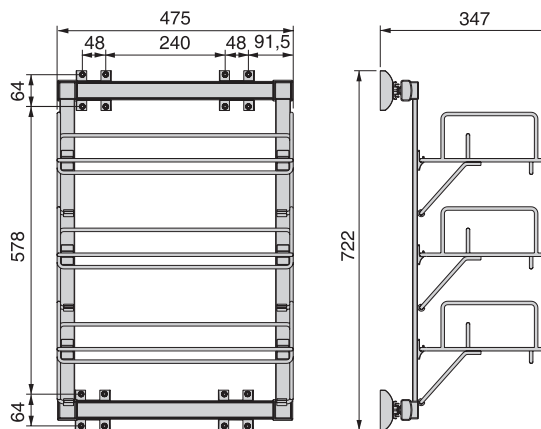
Sapateira lateral extraível tripla



Cod. 	
79137 25 1	
Acero y plástico Aço e plástico	



Colgador extensible auxiliar

Varão extraível de apoio

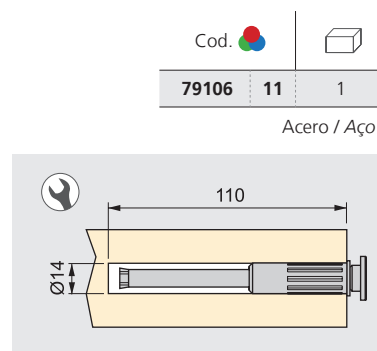
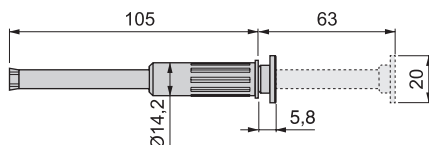

Cod. 



79106 11 1

Acero / Aço

Corbatero lateral extraíble

Porta gravatas lateral extraível

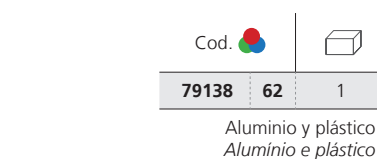
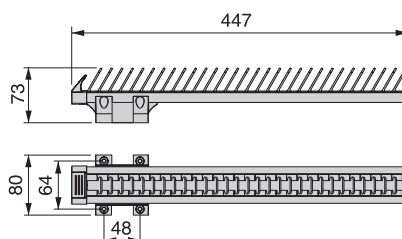

Cod. 



79138 62 1

Aluminio y plástico
Aluminio e plástico

Porta cinturones extraíble

Porta cintos extraível

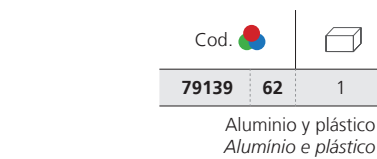
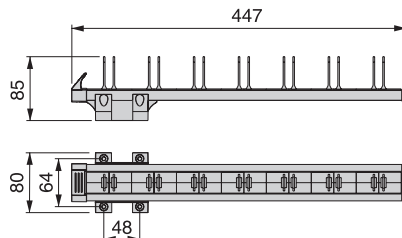

Cod. 



79139 62 1

Aluminio y plástico
Aluminio e plástico

Juego de distanciadores para extraíbles Keeper

Jogo de distanciadores para extraíveis Keeper

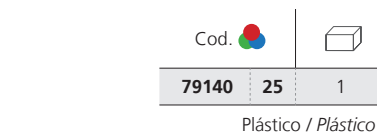
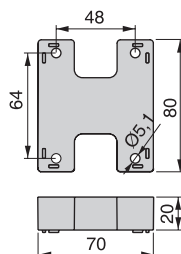

Cod. 



79140 25 1

Plástico / Plástico



Para utilizar con puertas abisagradas o suplementar medidas de hueco de módulo.

Para utilizar com portas de abrir com dobradiças ou acrescentar medidas de espaço interior do módulo.

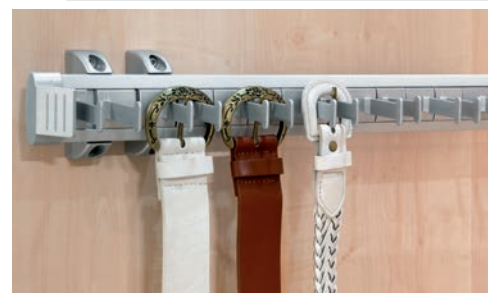

Pantalonero extraíble 8 varillas

Porta calças extraível 8 varetas

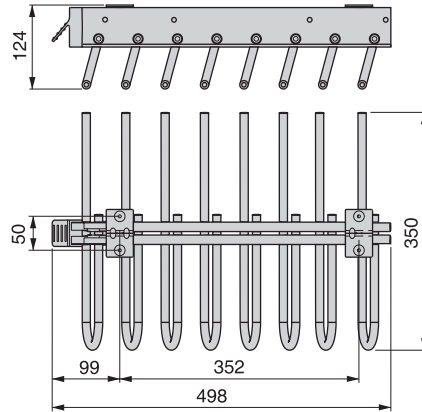

- Guías de 450 mm de extracción total.
- Incorpora un tirador para facilitar la extracción.
- Incluye tornillos para montaje.
- Incluye gomas antideslizantes.

- Corrediças de 450 mm de extração total.
- Incorpora um puxador para facilitar a sua extração.
- Inclui os parafusos para a sua montagem.
- Inclui gomas antideslizantes.

Mano / Mão	Cod.		
Izquierda / Esquerda	69128	25	1
Derecha / Direita	69234	25	1

Acero y plástico
Aço e plástico

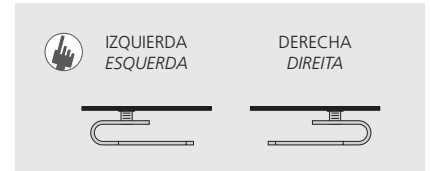

Colgador extraíble

Varão trombone extraível

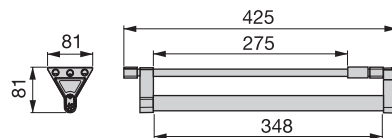

Cod.		
69163	62	1



Aluminio / Alumínio

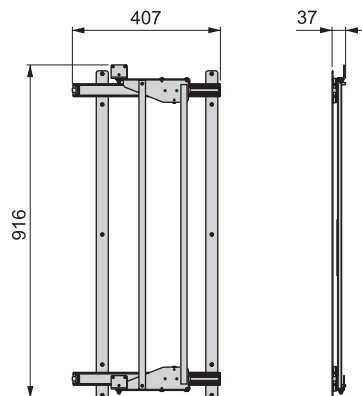

Guías para espejo extraíble

Corrediças para espelho extraível



Cod. 		
70106	25	1
Acero / Aço		



- Extracción del espejo mediante guías de bolas.
- Profundidad mínima del módulo 410 mm.
- Se suministra con tornillos para su montaje.
- Espejo no incluido.

- *Extração do espelho através de corrediças de rolamentos.*
- *Profundidade mínima do módulo 410 mm.*
- *Fornece-se com parafusos para a sua montagem.*
- *Espelho não incluído.*

Espejo Plus 15 para guía extraíble

Espelho Plus 15 para corrediça extraível

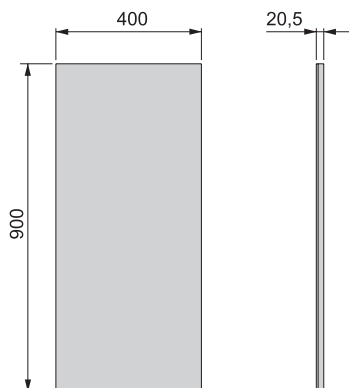
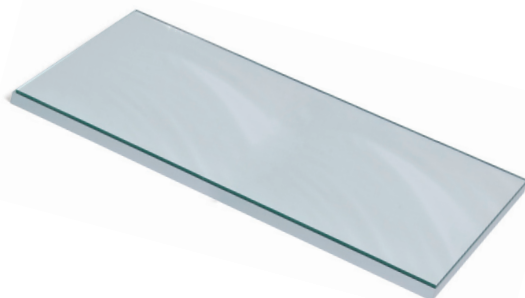

Cod. 		
70107	62	1
Aluminio y cristal Alumínio e vidro		

- Incluye tornillos de montaje.
- Vitrina Plus 15.
- *Inclui parafusos de montagem.*
- *Vitrine Plus 15.*



ACCESORIOS SELF

ACESSÓRIOS SELF

Pantalonero extraíble 11 varillas

Porta calças extraível 11 varetas

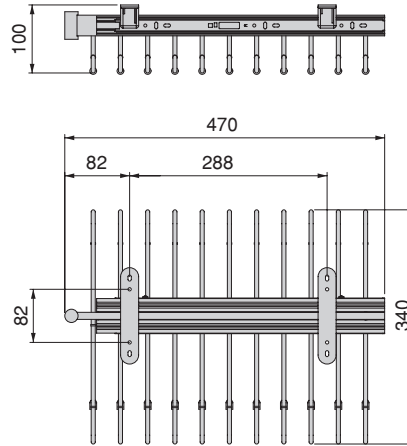

- Guías de extracción total.
- Incluye gomas antideslizantes.
- Corrediças de extração total.
- Inclui gomas antideslizantes.

Cod.  

70178 | 11 | 1

Acero / Aço

FORO TÉCNICO
FORUM TÉCNICO



www.emuca.com

Pantalonero lateral extraíble

Porta calças lateral extraível

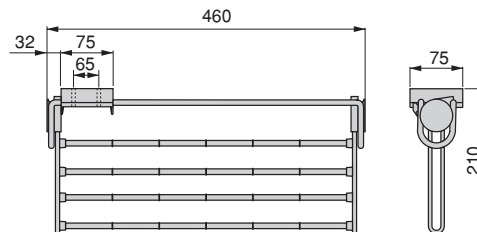

Cod.  

62111 | 25 | 1

Acero y plástico
Aço e plástico

Zapatero

Sapateira

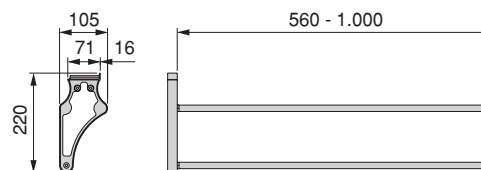

Cod.  

62112 | 25 | 1

Acero y plástico
Aço e plástico



Colgador extraíble 800

Varão trombone extraível de 800

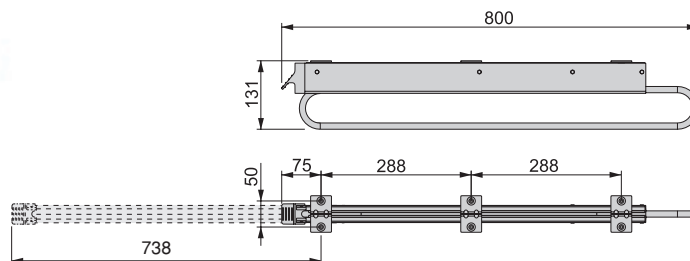

Cod. 



70057	25	1
-------	----	---

Acero y plástico
Aço e plástico

Corbatero portacinturones lateral extraíble

Porta gravatas e cintos lateral extraível

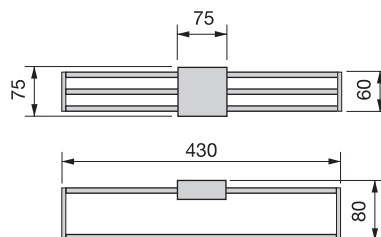

Cod. 





62110	25	10
-------	----	----

Acero y plástico
Aço e plástico

Colgador extraíble

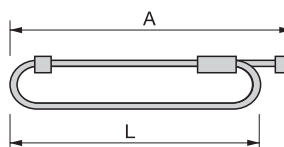
Varão trombone extraível



A	L	Cod. 	
335	300	62109	25 10
385	350	62108	25 10
435	400	62107	25 10
485	450	62106	25 10

Acero y plástico / Aço e plástico



PERFILES Y ACCESORIOS PARA PUERTAS DE MADERA

- 7.31 Información
- 7.33 Perfiles tirador enderezador Adige
- 7.34 Perfiles tirador enderezador Brenta
- 7.35 Perfiles tirador enderezador Free Face
- 7.37 Perfiles tirador enderezador Free Rapid
- 7.38 Perfiles tirador enderezador Rhodes
- 7.39 Perfiles tirador enderezador Sparta
- 7.40 Perfiles tirador enderezador Styl
- 7.40 Tiras guardapolvo para puertas correderas
- 7.41 Perfiles para cantos Face
- 7.42 Tensores para puertas

PERFIS E ACESSÓRIOS PARA PORTAS DE MADEIRA

- 7.31 Informação
- 7.33 Perfis puxador endireitador Adige
- 7.34 Perfis puxador endireitador Brenta
- 7.35 Perfis puxador endireitador Free Face
- 7.37 Perfis puxador endireitador Free Rapid
- 7.38 Perfis puxador endireitador Rhodes
- 7.39 Perfis puxador endireitador Sparta
- 7.40 Perfis puxador endireitador Styl
- 7.40 Fitas guarda-pó para portas de correr
- 7.41 Perfis para cantos Face
- 7.42 Esticadores para portas

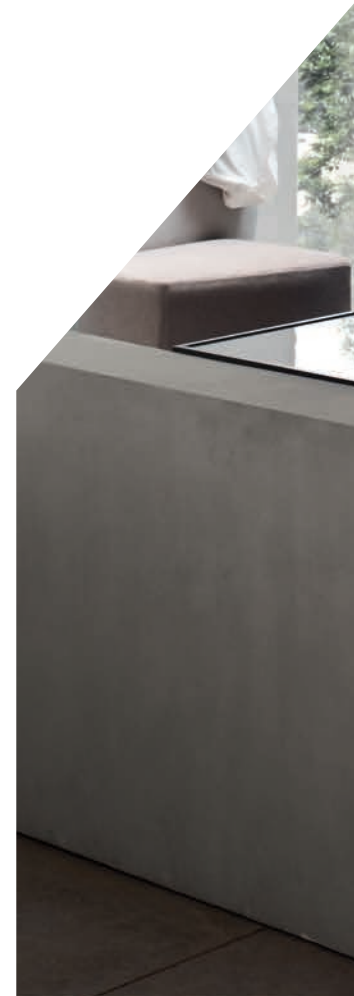
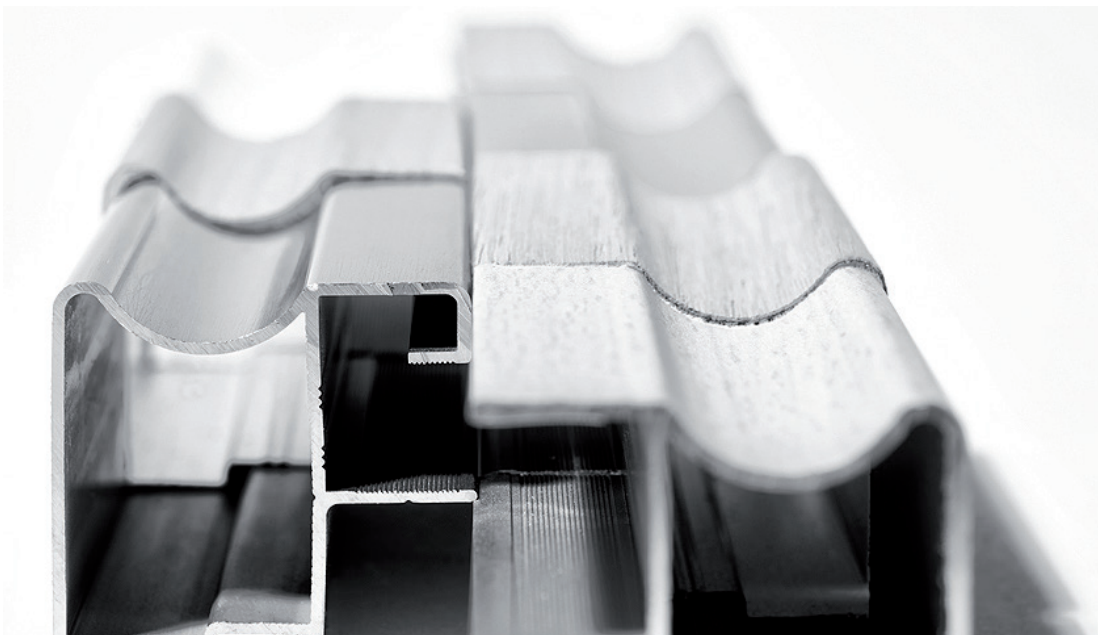





















INFORMACIÓN / INFORMAÇÃO

PERFILES / PERFS		 ACABADOS ACABAMENTO	ESPEJOR TABLERO ESPESSURA DO PAINEL		MATERIAL MATERIAL
 ADIGE	Perfil vertical <i>Perfil vertical</i>	62	 18mm		Aluminio Alumínio
	Perfil tirador <i>Perfil puxador</i>				
	Perfil tirador/tapa <i>Perfil puxador/tampa</i>				
 BRENTA	Perfil vertical <i>Perfil vertical</i>	62	 18mm		Aluminio Alumínio
	Perfil tirador <i>Perfil puxador</i>				
	Perfil tirador/tapa <i>Perfil puxador/tampa</i>				
 FREE FACE	Perfil vertical <i>Perfil vertical</i>	62	 19-20mm		Aluminio Alumínio
	Perfil tirador <i>Perfil puxador</i>				
	Perfil tirador/tapa <i>Perfil puxador/tampa</i>				
 FREE FACE 2	Perfil vertical <i>Perfil vertical</i>	62	 19-20mm		Aluminio Alumínio
	Perfil tirador <i>Perfil puxador</i>				
 FREE RAPID	Perfil vertical <i>Perfil vertical</i>	62	 19-20mm		Aluminio Alumínio
	Perfil tirador <i>Perfil puxador</i>				
 RODAS	Perfil tirador <i>Perfil puxador</i>	62	 19 mm		Aluminio Alumínio
 SPARTA	Perfil tirador <i>Perfil puxador</i>	62	 22 mm		Aluminio Alumínio
 STYL	Perfil tirador <i>Perfil puxador</i>	25	 16mm		Acero / Aço
	Perfil enderezador <i>Perfil endireitador</i>				

INFORMACIÓN / INFORMAÇÃO

	Espesor Espessura	SPACE +				NECO REGULABLE REGULÁVEL		NECO NO REGULABLE NÃO REGULÁVEL			SUPERECO
		23	30	35	50	23	30	21	23	28	19
ADIGE		✓	✓	-	-	✓	✓	✗	✓	✓	✗
		✓	✓	-	-	✓	✓	✗	✓	✓	✗
		✓	✗	✗	✗	✓	✗	✓	✓	✗	✗
BRENTA		✓	✓	-	-	✓	✓	✗	✓	✓	✗
		✓	✓	-	-	✓	✓	✗	✓	✓	✗
		✗	✓	✗	✗	✓	✗	✗	✗	✓	✗
FREE FACE		✗	✓*	-	-	✓	✓	✗	✗	-	✗
		✗	✓*	-	-	✗	✗	✗	✗	-	✗
		✗	✓*	✗	✗	✗	✗	✗	✗	✗	✗
FREE FACE 2		✓	✓	-	-	✓	✓	✗	✓	✓	✗
		✓	✓	-	-	✓	✓	✗	✓	✓	✗
FREE RAPID		✗	✓*	-	-	✗	✗	✗	✗	-	✗
		✗	✓*	-	-	✗	✗	✗	✗	✗	✗
		✗	✓*	✗	✗	✗	✗	✗	✗	✗	✗
RHODES		✓	-	-	-	✓	-	✓	✓	-	✗
SPARTA		✓	-	-	-	✓	-	✗	✓	-	✗
STYL		✓	-	-	-	✓	-	✓	✓	-	✓
		✓	-	-	-	✓	-	✓	✓	-	✓
FREE		✗	✓	-	-	✗	✗	✗	✗	✗	✗

✓ | Compatible
Compatível

✓* | Utilizar con distanciador adhesivo 4000820
Utilizar con distanciador adhesivo 4000820

✗ | No compatible
No compatível

- | Compatible pero no recomendado
Compatível pero no recomendado

PERFILES TIRADOR ENDEREZADOR ADIGE



PERFIS PUXADOR ENDIREITADOR ADIGE

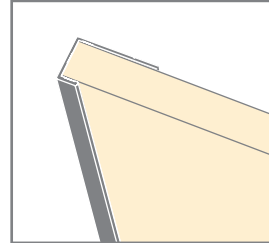
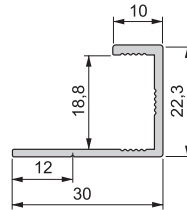

Perfil vertical Adige

Perfil vertical Adige





	Cod. 	
2,8 m	70134 62	28 m
Aluminio / Alumínio		

Perfil tirador Adige

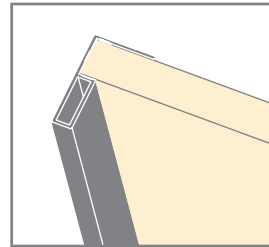
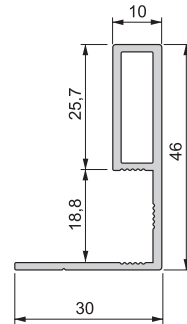
Perfil puxador Adige





	Cod. 	
2,8 m	70132 62	28 m
Aluminio / Alumínio		

Perfil tirador/tapa Adige

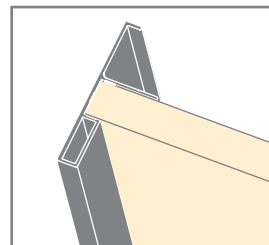
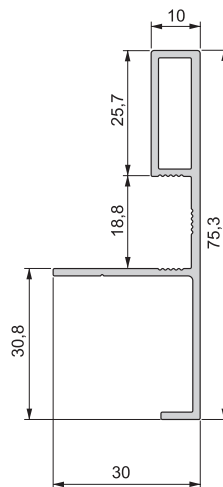
Perfil puxador/tapa Adige



	Cod. 	
2,8 m	70133 62	28 m
Aluminio / Alumínio		



MEDIDA DE CORTE DEL TABLERO
 Restar 4 mm del ancho de la puerta.

MEDIDA DE CORTE DO PAINEL OU CHAPA
 Subtrair 4 mm à largura da porta.



FORO TÉCNICO
 FORUM TÉCNICO

www.emuca.com



PERFILES TIRADOR ENDEREZADOR BRENTA



PERFIS PUXADOR ENDIREITADOR BRENTA

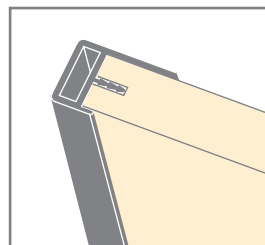
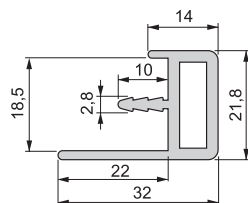
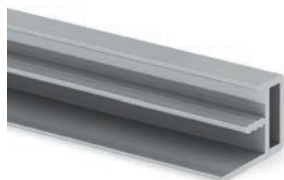

Perfil vertical Brenta

Perfil vertical Brenta





	Cod. 	
2,8 m	70137 62	28 m
Aluminio / Alumínio		

Perfil tirador Brenta

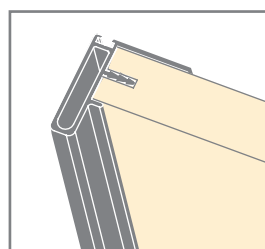
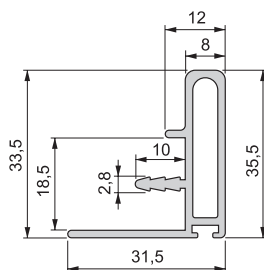
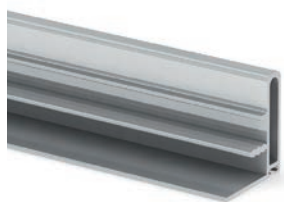
Perfil puxador Brenta





	Cod. 	
2,8 m	70135 62	28 m
Aluminio / Alumínio		

Perfil tirador/tapa Brenta

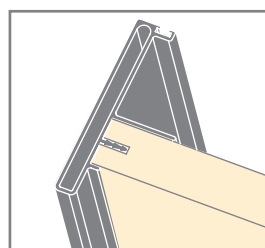
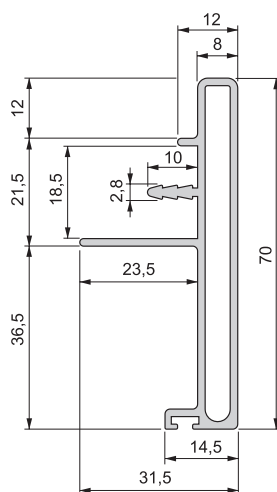
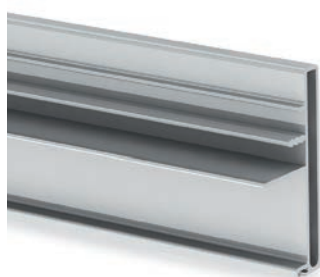
Perfil puxador/tapa Brenta



	Cod. 	
2,8 m	70136 62	28 m
Aluminio / Alumínio		

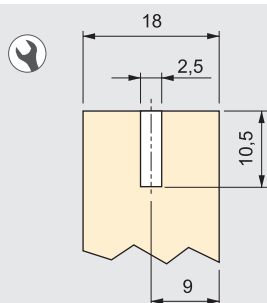

Para calcular la medida de corte del tablero restar 18 mm al ancho de puerta.

Para calcular a medida de corte do painel ou chapa subtrair 18 mm à largura da porta.



No válido para los perfiles guardapolvos Cod. 90451 21, 90342 21 y 90341 21.

Não válido para os perfis guarda pós Cod. 90451 21, 90342 21 e 90341 21.

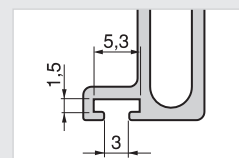

PERFILES TIRADOR ENDEREZADOR FREE FACE





PERFIS PUXADOR ENDIREITADOR FREE FACE

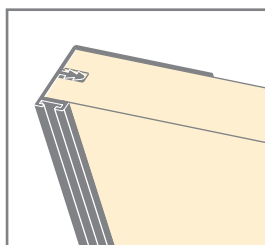
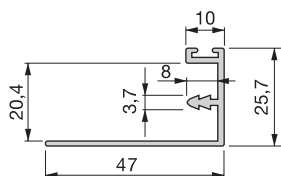

Perfil vertical Free Face

Perfil vertical Free Face



	Cod. 	
2,6 m	60012 62	26 m
3 m	58727 62	30 m
2,6 m	61795 62	 m

Aluminio / Alumínio







Para sistema corredero Space+ utilizar con Cod. 4000820.

Para sistema de correr Space+ utilizar com Cod. 4000820.

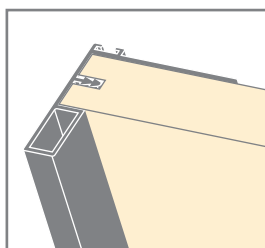
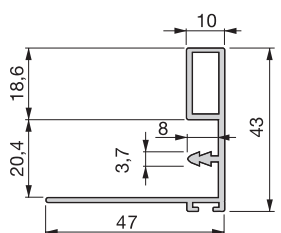
Perfil tirador Free Face

Perfil puxador Free Face







	Cod. 	
2,6 m	60013 62	26 m
3 m	58728 62	30 m
2,6 m	62155 62	 m

Aluminio / Alumínio

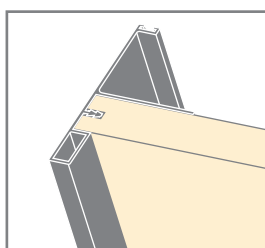
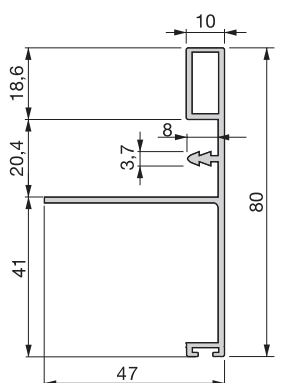
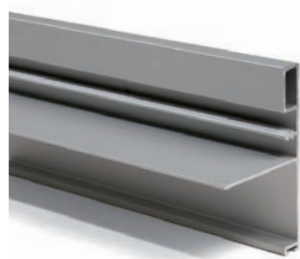
Perfil tirador/tapa Free Face

Perfil puxador/tampa Free Face



	Cod. 	
2,6 m	60014 62	13 m
3 m	58729 62	15 m
2,6 m	65162 62	 m

Aluminio / Alumínio

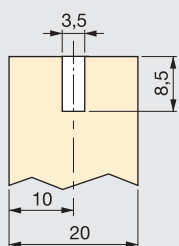

Para calcular la medida de corte del tablero restar 4 mm al ancho de puerta.

Para calcular a medida de corte do painel ou chapa subtrair 4 mm à largura da porta.



Permite la utilización con los perfiles guarda-polvos Cod. 90451 21, 90342 21 y 90341 21.





Permite a utilização com os perfis guarda pó Cod. 90451 21, 90342 21 e 90341 21.



pag. 7.40

Perfil vertical Free Face 2

Perfil vertical Free Face 2



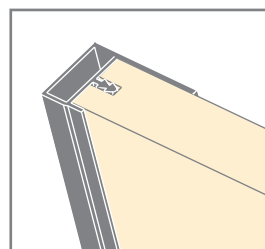
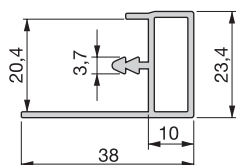

	Cod. 	
2,6 m	61471	62 26 m
2,6 m	61472	62  m

Aluminio / Alumínio





Perfil tirador Free Face 2

Perfil puxador Free Face 2

	Cod. 	
2,6 m	61473	62 26
2,6 m	61474	62  m

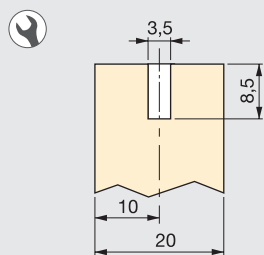
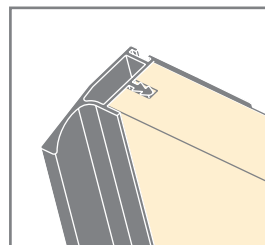
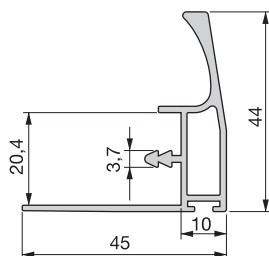
Aluminio / Alumínio



 Para calcular la medida de corte del tablero restar 20 mm al ancho de puerta.

Para calcular a medida de corte do painel ou chapa subtrair 20 mm à largura da porta.

 Permite la utilización con los perfiles guardapolvos Cod. 90451 21, 90342 21 y 90341 21.
 Permite a utilização com os perfis guarda pós Cod. 90451 21, 90342 21 e 90341 21.



pag. 7.40

PERFILES TIRADOR ENDEREZADOR FREE RAPID





PERFIS PUXADOR ENDIREITADOR FREE RAPID

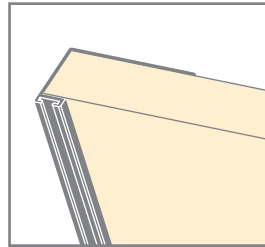
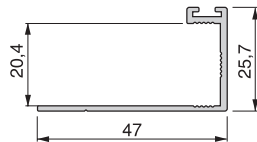

Perfil vertical Free Rapid

Perfil vertical Free Rapid



	Cod. 	
2,6 m	70077 62	26 m
2,6 m	70076 62	 m

Aluminio / Alumínio







Para sistema corredero Space+ utilizar con Cod. 4000820.

Para sistema de correr Space+ utilizar com Cod. 4000820.

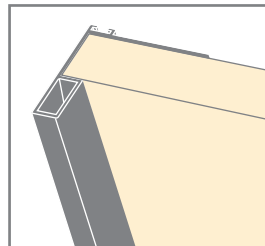
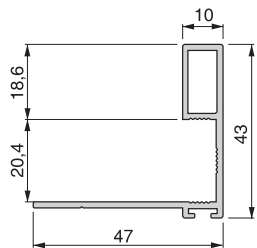
Perfil tirador Free Rapid

Perfil puxador Free Rapid







	Cod. 	
2,6 m	70081 62	26 m
2,6 m	70080 62	 m

Aluminio / Alumínio

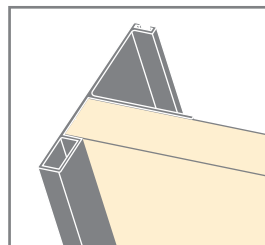
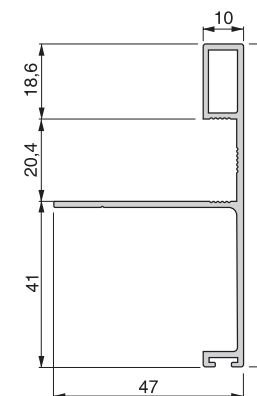
Perfil tirador/tapa Free Rapid

Perfil puxador/tampa Free Rapid



	Cod. 	
2,6 m	70085 62	13 m
2,6 m	70084 62	 m

Aluminio / Alumínio

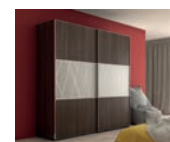

SISTEMAS
CORREDEROS
SISTEMAS
DE CORRER

www.emuca.com

6



Para calcular la medida de corte del tablero restar 4 mm al ancho de puerta.

Para calcular a medida de corte do painel ou chapa subtrair 4 mm à largura da porta.



Permite la utilización con los perfiles guardapolvos Cod. 90451 21, 90342 21 y 90341 21.

Permite a utilização com os perfis guarda pós Cod. 90451 21, 90342 21 e 90341 21.



pag. 7.40



PERFILES TIRADOR ENDEREZADOR RHODES

PERFIS PUXADOR ENDIREITADOR RHODES



Rhodes

Rhodes

	Cod. 	
3 m	92966 62	30 m
Aluminio / Alumínio		

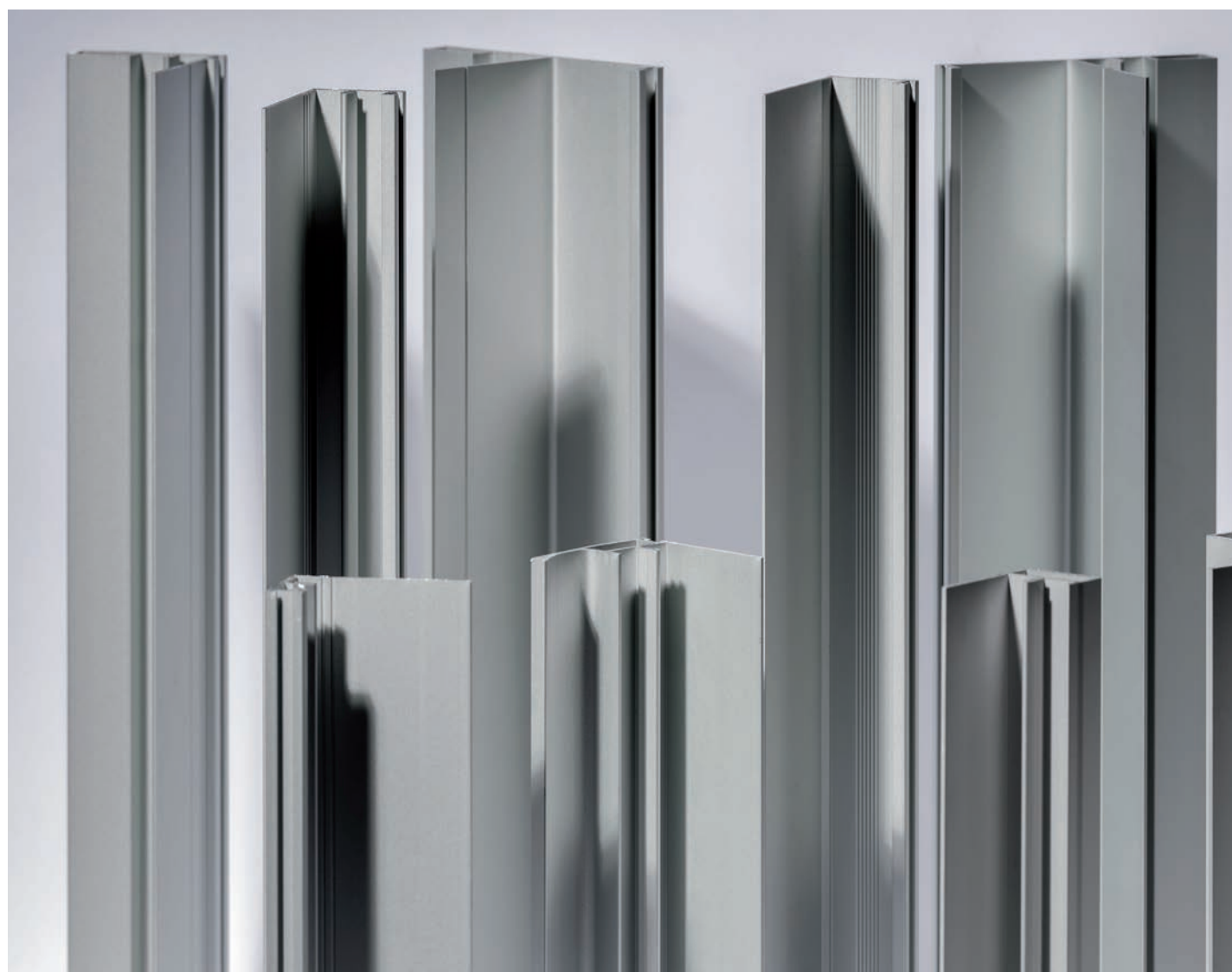
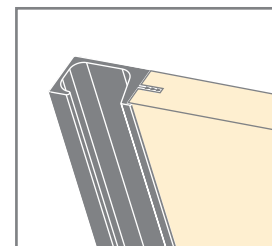
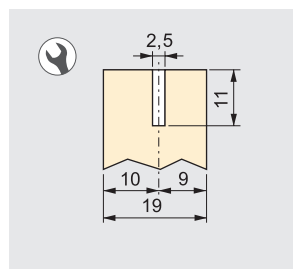
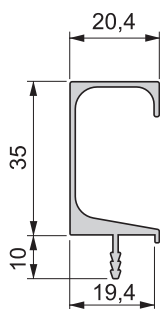



PERFILES TIRADOR ENDEREZADOR SPARTA

PERFIS PUXADOR ENDIREITADOR SPARTA



Sparta

Sparta

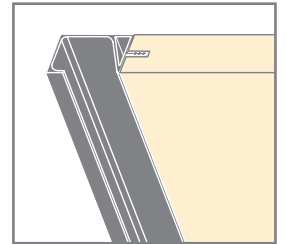
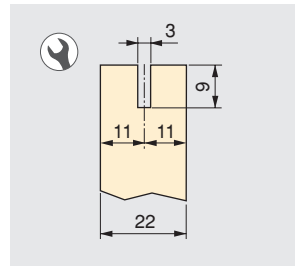
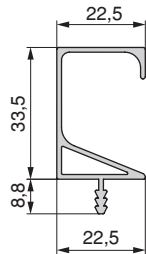

	Cod. 	
2,8 m	92910 62	28 m

Aluminio / Alumínio



Tapas laterales Sparta

Tampas laterais Sparta

Cod. 	
92911 25	10

Plástico / Plástico

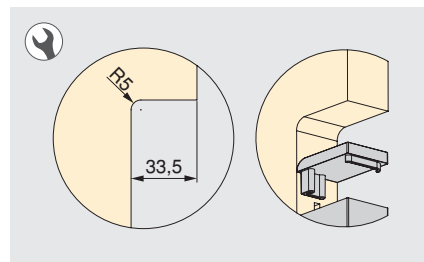
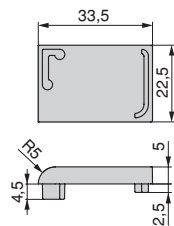

PERFILES TIRADOR ENDEREZADOR STYL

PERFIS PUXADOR ENDIREITADOR STYL



- Diseñados para ser utilizados con el sistema corredero Space + (23mm), Neco, Supereco y Glider 2/3.
- Dispone de agujeros Ø 6,5 para la fijación al tablero cada 320mm.
- Incluye film protector.
- Consultar condiciones para espesor de 18 y 19mm.

- *Desenhados para serem utilizados com o sistema de correr Space+ (23mm) Neco, Supereco e Glider 2/3.*
- *Possui furos de Ø 6,5 para a fixação ao painel ou chapa cada 320mm.*
- *Inclui película de proteção.*
- *Consultar condições para espessura 18 y 19mm.*

Pefil tirador Styl

Perfil puxador Styl

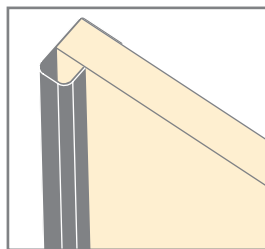
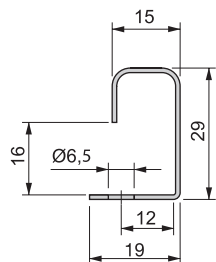

L	Cod.	Color	Box
2,355 m	70161	25	23,55 m
2,355 m	70160	25	m

Acero / Aço

Pefil enderezador U Styl

Perfil endireitador U Styl

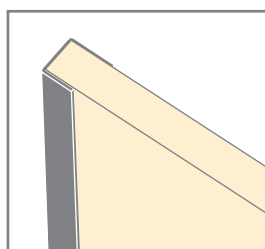
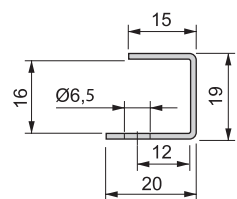

L	Cod.	Color	Box
2,355 m	70163	25	23,55 m
2,355 m	70162	25	m

Acero / Aço



MEDIDA DE CORTE DEL TABLERO
 Restar 2 mm del ancho de la puerta.

MEDIDA DE CORTE DO PAINEL OU CHAPA
 Subtrair 2 mm à largura da porta.

TIRAS GUARDAPOLVO PARA PUERTAS CORREDERAS

FITAS GUARDA-PÓ PARA PORTAS DE CORRER

Perfiles sin adhesivo

Perfis sem adesivo

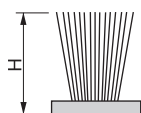

Hueco recomendado para el montaje del guardapolvo

Espaço interior recomendado para a montagem do guarda pó

H	Cod.	Color	Box
5	90451	21	375 m
7	90342	21	225 m
9	90341	21	175 m

Plástico / Plástico

Perfiles con adhesivo

Perfis com adesivo

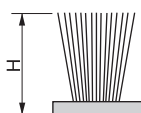

H	Cod.	Color	Box
7	91299	21	400 m
9	90343	21	300 m
17	90540	21	125 m

Plástico / Plástico







PERFILES PARA CANTOS FACE

PERFIS PARA CANTOS FACE

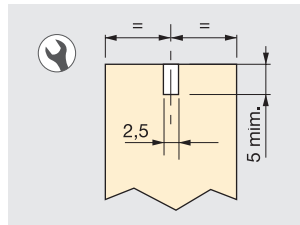
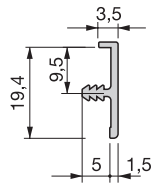
Face 2

Face 2







		Cod. 	
3,2 m	19	62252 62	80 m

Aluminio / Alumínio

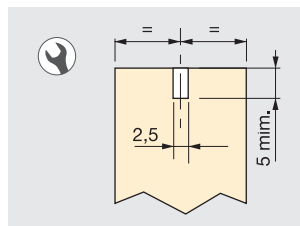
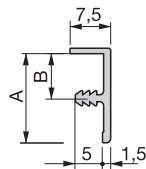
Face 3

Face 3







	A	B		Cod. 	
3,2 m	17,4	8	16	62251 62	80 m
3,2 m	19,4	9,5	19	62253 62	80 m

Aluminio / Alumínio

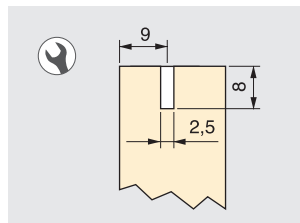
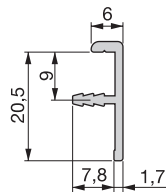
Face 4

Face 4







		Cod. 	
3,2 m	19	61118 62	80 m

Aluminio / Alumínio

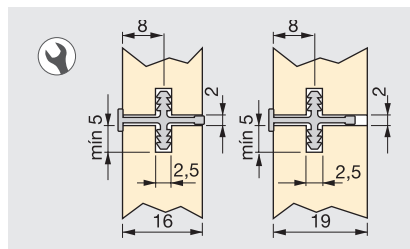
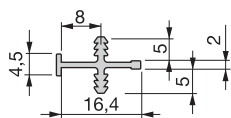
Face H

Face H



	Cod. 	
4 m	62331 62	80 m



Aluminio / Alumínio

- Se puede utilizar para simular el travesaño de una puerta o como división en sistemas de panelaje.
- Pode-se utilizar para simular o perfil japonesa de divisão horizontal de uma porta ou como divisão em sistemas de painéis.

Face T

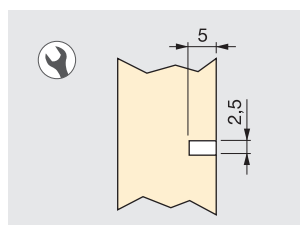
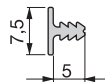
Face T



	Cod. 	
3,2 m	62418 62	80 m

Aluminio / Alumínio



TENSORES PARA PUERTAS

ESTICADORES PARA PORTAS

Tensor Steady

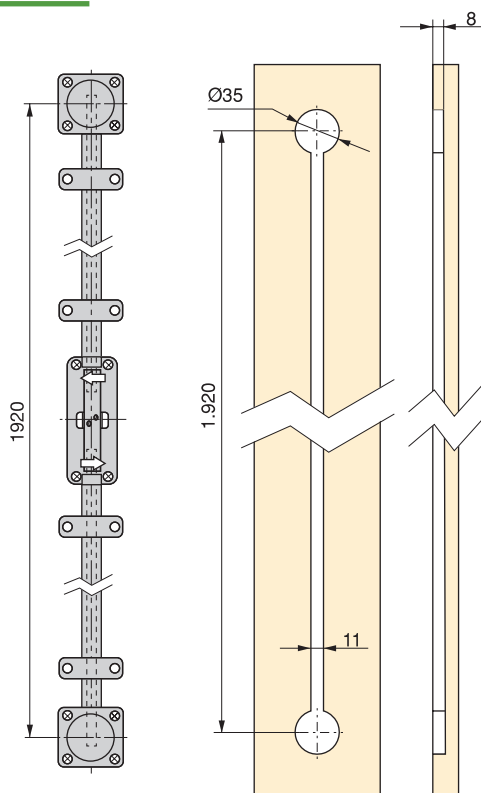
Esticador Steady





Cod.		
91145	61	25

Acero, aluminio y plástico
 Aço, alumínio e plástico

Tensor Tigth

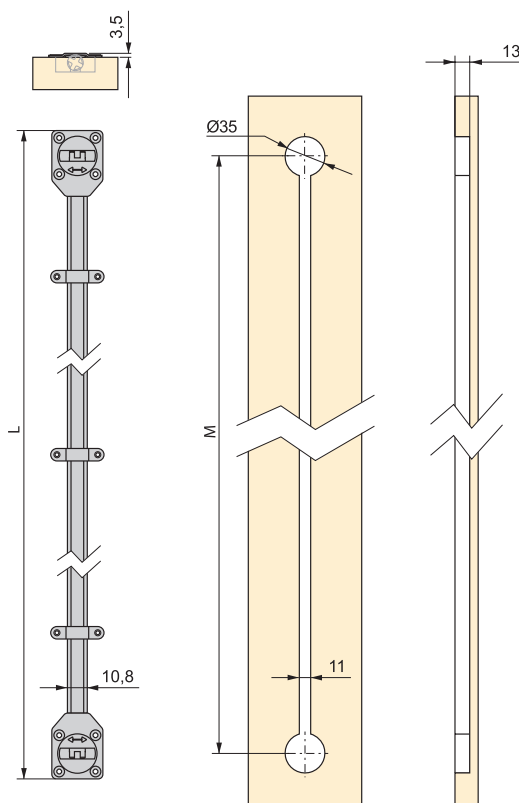
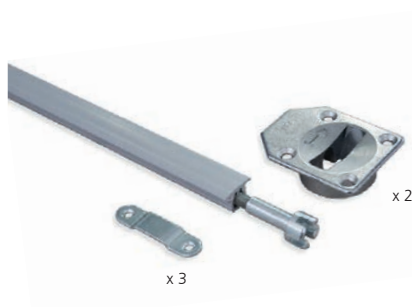
Esticador Tigth



L	M	Cod.		
1.964	1.920	43943	21	25
2.284	2.240	79126	21	25

Acero, plástico y zamak
 Aço, plástico e zamak

PUERTAS DE ALUMINIO PARA ARMARIO

7.45 Puertas Free
7.47 Perfiles Free

PORTAS DE ALUMÍNIO PARA ROUPEIRO

7.45 *Portas Free*
7.47 *Perfis Free*





PUERTAS FREE

PORTAS FREE



SPACE +

GLIDER
3



- Puertas de aluminio para sistemas correderos Space + y Glider 3.
- Los perfiles no precisan de mecanizados, sólo corte en recto.
- Acabados: aluminio mate, brillo y lacado negro.
- *Portas de alumínio para sistemas de correr Space + e Glider 3.*
- *Os perfis não precisam de mecanizações, só de corte recto.*
- *Acabamentos: alumínio mate, brilho e lacado preto.*

Puertas Free

Portas Free

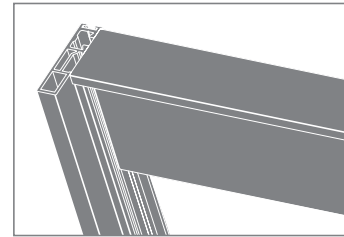
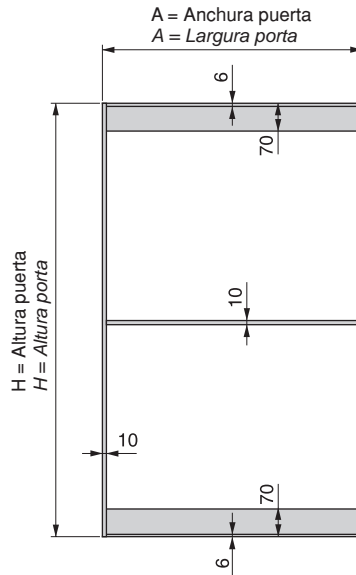

SISTEMAS
CORREDEROS
SISTEMAS
DE CORRER

www.emuca.com

6



INSTALACIÓN DE 2 PUERTAS
INSTALAÇÃO DE 2 PORTAS

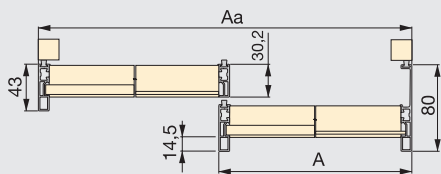

INSTALACIÓN DE 3 PUERTAS
INSTALAÇÃO DE 3 PORTAS

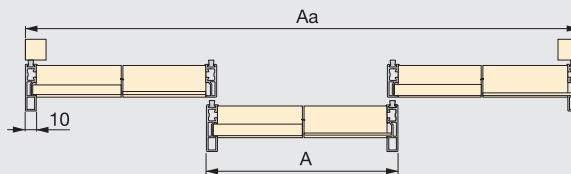

Para puertas chapadas en madera se recomienda utilizar tablero o cristal opaco.

Para portas em acabamento de chapa de madeira recomenda-se utilizar painéis, chapas de aglomerado ou vidro opaco (lacado).



Cálculo de la puerta Cálculo da porta														
	Armario 2 puertas Roupeiro 2 portas	Armario 3 puertas Roupeiro 3 portas												
A	$\frac{Aa + 8}{2}$	$\frac{Aa + 18}{3}$												
<table border="1" style="width: 100%;"> <thead> <tr> <th colspan="2">Space +</th> <th colspan="2">Glider 3</th> </tr> </thead> <tbody> <tr> <td>H</td> <td>Ha + 87</td> <td>H</td> <td>HI - 8</td> </tr> <tr> <td colspan="2">Ha = altura total del armario Ha = altura total do roupeiro</td> <td colspan="2">HI = altura hueco interior HI = altura do espaço interior</td> </tr> </tbody> </table>			Space +		Glider 3		H	Ha + 87	H	HI - 8	Ha = altura total del armario Ha = altura total do roupeiro		HI = altura hueco interior HI = altura do espaço interior	
Space +		Glider 3												
H	Ha + 87	H	HI - 8											
Ha = altura total del armario Ha = altura total do roupeiro		HI = altura hueco interior HI = altura do espaço interior												

Cálculo del cristal o tablero Cálculo do vidro ou painel		
	Cristal-4 / Tablero-11 Vidro-4 / Painel-11	Tablero-10 Painel-10
Anchura Largura	A - 14	A - 13
Altura Altura	$\frac{H - 5,5 - (4 \times N)}{N + 1}$	$\frac{H - 4,5 - (3 \times N)}{N + 1}$
N = número de travesaños N = número de japonesas (perfis de divisões horizontais)		

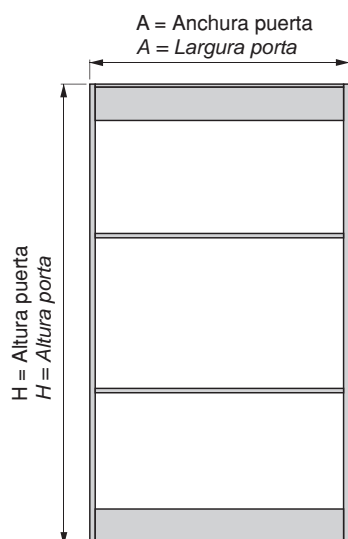

Puertas estándar Free

Portas standard Free





- Se suministran listas para el montaje.
 - Los perfiles de aluminio que configuran esta puerta van cortados en recto, por lo que el cliente puede recortarse las puertas estándar a su medida.
 - Incluye instrucciones de montaje.
-
- São fornecidas listas para a montagem.
 - Os perfis de alumínio que configuram esta porta são cortados em corte recto, pelo que o cliente pode posteriormente recortar as portas standard à sua medida.
 - Inclui instruções de montagem.

PERFILES VERTICALES PARA UNA PUERTA:
 PERFIS VERTICAIS PARA UMA PORTA:

H	Puerta Porta	Cod. 	
2.500	A	69086	62 1
2.500	B	69087	62 1
2.500	C	69088	62 1
2.900	A	58842	62 1
2.900	B	58843	62 1
2.900	C	58844	62 1

Aluminio / Alumínio

PERFILES HORIZONTALES PARA UNA PUERTA:
 PERFIS HORIZONTAIS PARA UMA PORTA:

A	Descripción Descrição	Cod. 	
1.200	Superior e inferior Superior e inferior	69089	62 1
1.600	Superior e inferior Superior e inferior	69090	62 1
1.200	Intermedio visto Perfil japonesa	69091	62 2
1.600	Intermedio visto Perfil japonesa	69092	62 2

Aluminio / Alumínio

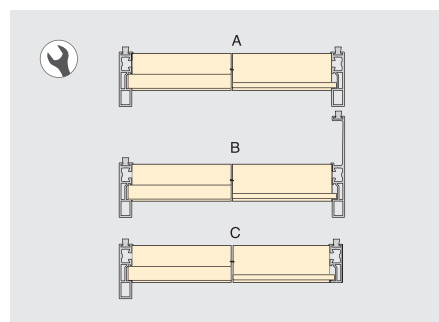



Cálculo de la medida de corte de los perfiles:
 Verticales = H
 Horizontales = A - 20mm

Cálculo da medida de corte dos perfis:
 Verticais = H
 Horizontais = A - 20mm

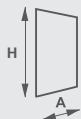









YouTube



www.emuca.com

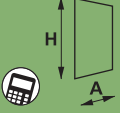
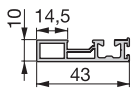
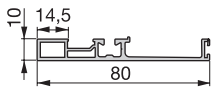
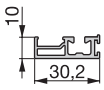
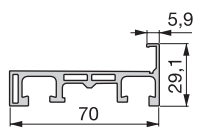
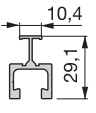

PERFILES FREE

PERFIS FREE

FREE Croquis / Esboço			 SERVICIO EN STOCK SERVIÇO EM STOCK			DATOS / DADOS
			Perfil / Perfil			Corte perfiles / Corte perfis
			Cod. 			
FREE	Tirador Puxador		69094 62	2,6 m	31,2 m	H
			58857 62	3 m	36 m	H
	Tirador tapa Puxador-tampa		69095 62	2,6 m	15,6 m	H
			58858 62	3 m	18 m	H
	Vertical Vertical		69093 62	2,6 m	15,6 m	H
			58856 62	3 m	18 m	H
	Superior / Inferior Superior / Inferior		60027 62	3 m	18 m	A - 20
	Intermedio visto Perfil japonesa		69097 62	3 m	36 m	A - 20
	Intermedio oculto Perfil japonesa oculto		60009 62	3 m	36 m	A - 20
	ACCESORIOS ACESSÓRIOS	Junquillo para cristal 4mm Perfil vedante para vidro 4mm		69085 21	3 m	60 m
Guardapolvo Guarda pó			90342 21	-	225 m	-

Herrajes para una puerta Free

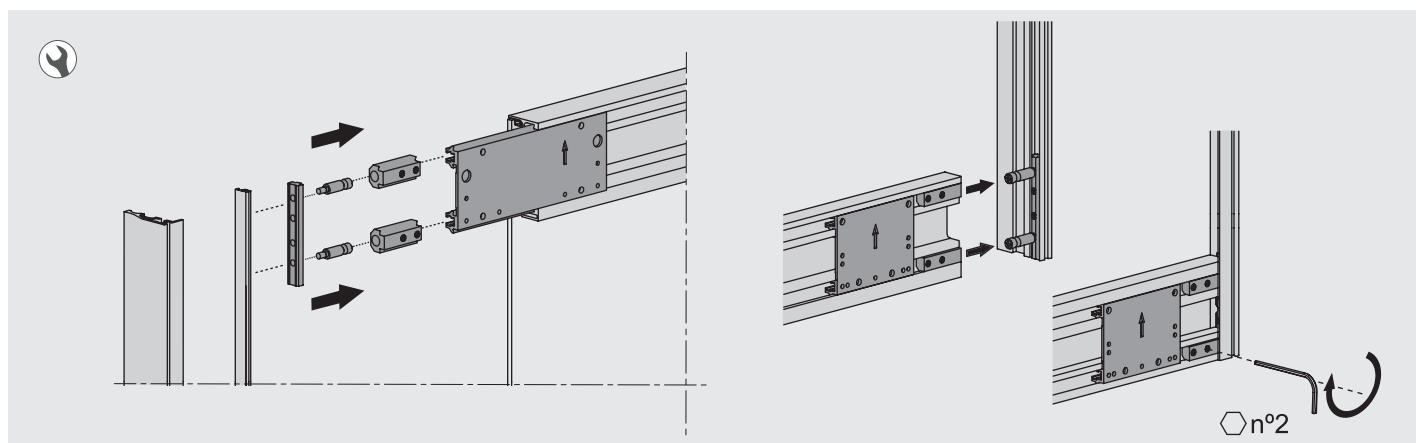
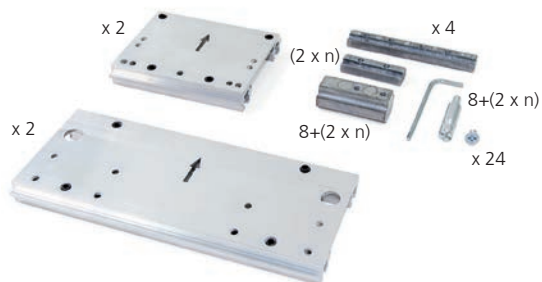

Ferragens para uma porta Free

Sist. corredero Sist. de correr	Nº travesaños horizontales Nº perfis japonesa horizontais	Cod. 	
Space +	1	70168	20 1
Space +	2	70169	20 1
Space +	3	70170	20 1



Unión T para travesaños Free

União em T para perfis japonesa Free (divisões horizontais)

Cod. 	
61006	20 1

Acero y zamak
Aço e zamak

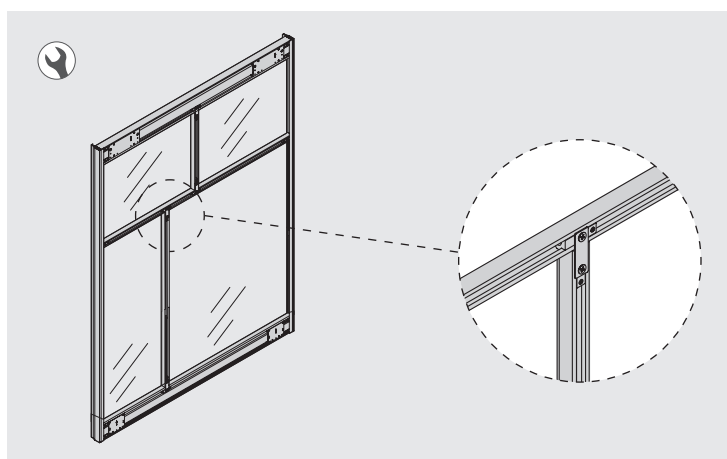
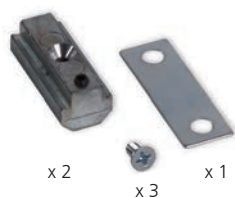

ESTRUCTURAS MODULARES

- 7.51 Sistema Jagmet
- 7.53 Sistema Tram

ESTRUTURAS MODULARES

- 7.51 *Sistema Jagmet*
- 7.53 *Sistema Tram*





SISTEMA JAGMET

SISTEMA JAGMET



- Sistema de perfiles para realizar composiciones de estanterías tanto de madera como de cristal.
 - Dos modelos distintos de perfil y soporte, con ranura sencilla o ranura doble.
-
- Sistema de perfis para realizar composições de prateleiras tanto de madeira como de vidro.
 - Dois modelos diferentes de perfil e suporte, com ranhura simples ou o ranhura dupla.

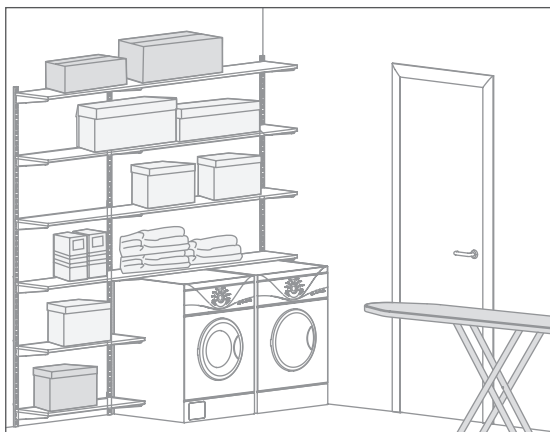
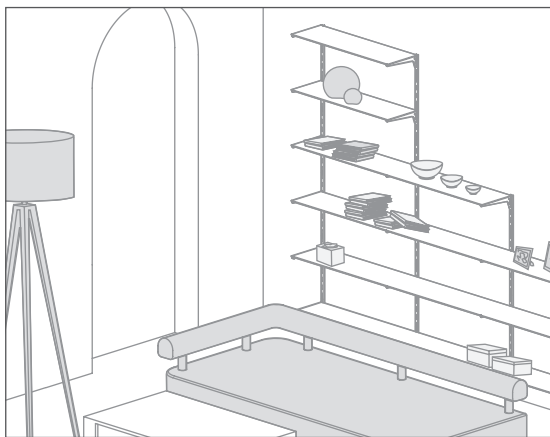



JAGMET

Perfil Jagmet ranura simple paso 50mm

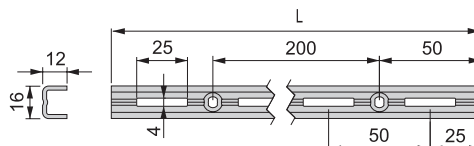
Perfil Jagmet de ranhura simples de passo 50mm





L	Cod. 	
1 m	79180	12 10
1,5 m	79164	12 10
2 m	79165	12 10
2,5 m	79166	12 10

Acero / Aço

Perfil Jagmet ranura doble paso 32mm

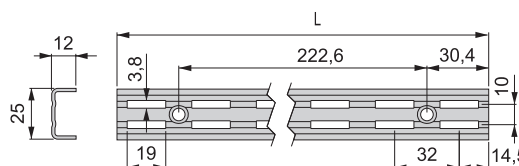
Perfil Jagmet de ranhura dupla de passo 32mm





L	Cod. 	
0,951 m	79167	12 10
1,396 m	79168	12 10
2,064 m	79169	12 10
2,229 m	79179	12 10

Acero / Aço

Soporte estante Jagmet ranura simple paso 50mm

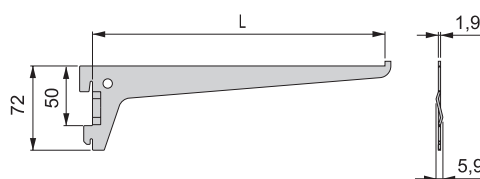
Soporte de prateleira Jagmet de ranhura simples de passo 50mm





L	Kg	Cod. 	
200	40	79170	12 20
250	32	79156	12 20
300	26	79157	12 20
350	23	79158	12 20
400	20	79159	12 20

Acero / Aço

Soporte estante Jagmet ranura doble paso 32mm

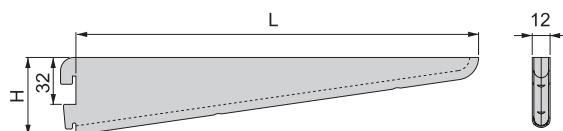
Soporte de prateleira Jagmet de ranhura dupla de passo 32mm



L	H	Kg	Cod. 	
170	47	44	79160	12 20
220	49	34	79161	12 20
270	52	27	79162	12 20
320	58	23	79181	12 20
370	64	20	79163	12 20
470	81,9	16	79182	12 20

Acero / Aço

SISTEMA TRAM

SISTEMA TRAM



- Sistema modular de perfiles y accesorios.
- Fabricado en aluminio anodizado mate.
- *Sistema modular de perfis e acessórios.*
- *Fabricado em alumínio anodizado mate.*



Consulta nuestra página web
 Veja o nosso site
www.emuca.com





TRAM

Perfil Tram

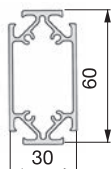
Perfil Tram





	Cod. 	
3 m	61123 62	18 m
Aluminio / Alumínio		

Unión 2 perfiles

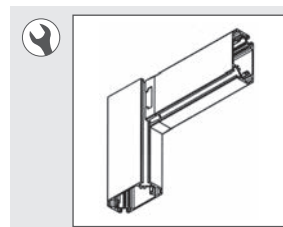
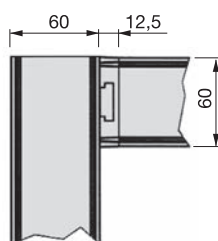
União para 2 perfis





Cod. 	
61093 25	1
Zamak / Zamak	

Unión 3 perfiles

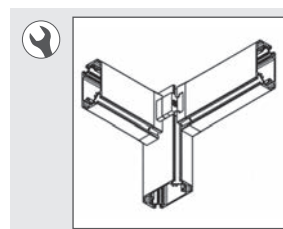
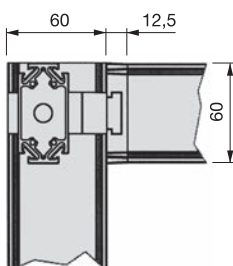
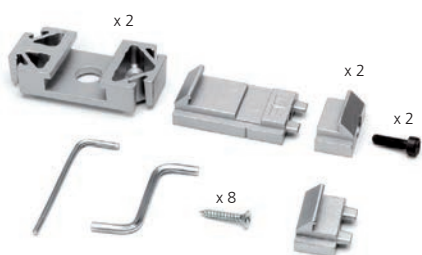
União para 3 perfis





Cod. 	
61094 25	1
Zamak / Zamak	

Unión 4 perfiles

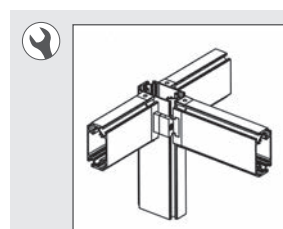
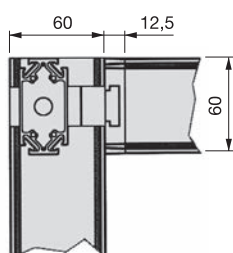
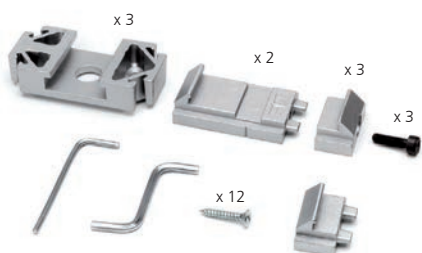
União para 4 perfis



Cod. 	
61283 25	1
Zamak / Zamak	

TRAM

Fijación al suelo / techo

Fixação ao chão / teto

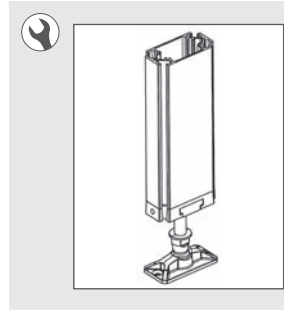
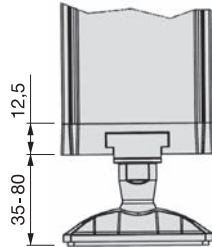



Cod. 	
61156	25 1
Plástico y zamak Plástico e zamak	

Fijación a la pared

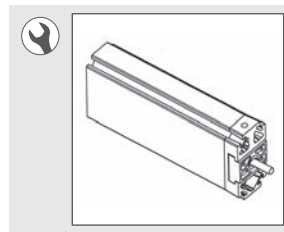
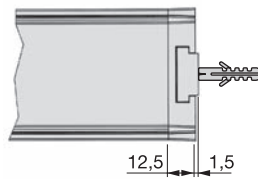
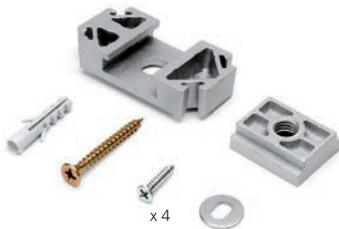
Fixação à parede





Cod. 	
61113	25 1
Zamak / Zamak	

Tapa embellecedora

Tampa embelezadora



Cod. 	
61284	21 10
Plástico / Plástico	



TRAM

Soporte estante madera

Soporte para prateleira de madeira

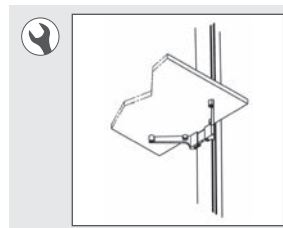
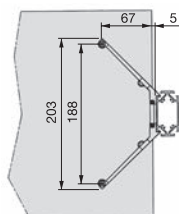

Cod. 



61047 25 1

Zamak / Zamak

Soporte estante cristal

Soporte para prateleira de vidro

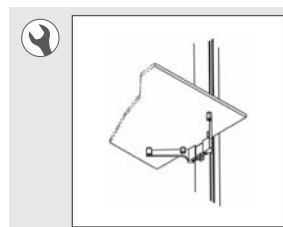
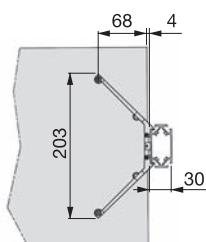

Cod. 



61054 25 1

Zamak / Zamak

- Para cristal de 4 a 10mm.
- Para vidro de 4 a 10mm.

Estante madera inclinado giratorio

Soporte para prateleira de madeira inclinada e giratória

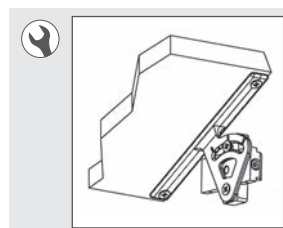
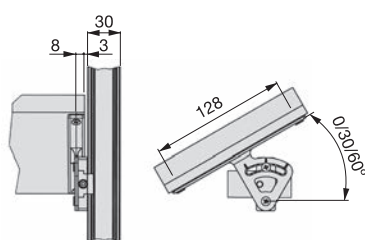
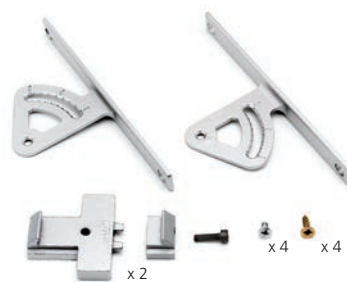

Cod. 



61073 25 1

Zamak / Zamak

Soporte para módulo

Soporte para módulo

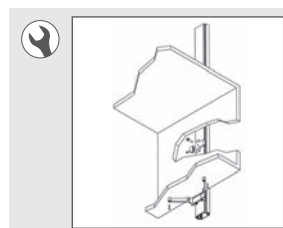
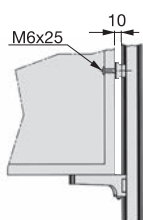
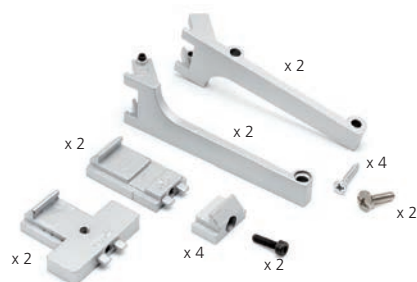

Cod. 



61169 25 1

Zamak / Zamak

TRAM

Soporte para barra de colgar

Suporte para varão de roupeiro

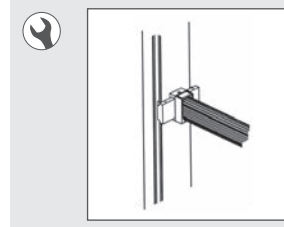
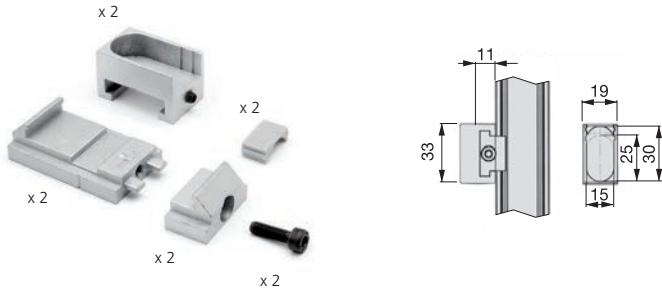

Cod. 



61090	25	1
-------	----	---

Zamak / Zamak

Soporte para barra abatible Hang

Suporte para varão basculante abatível Hang

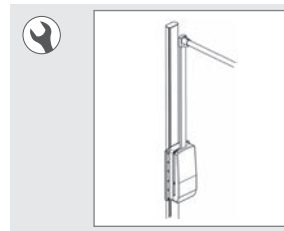
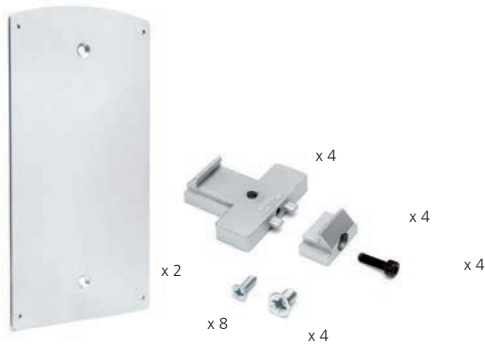

Cod. 



61082	25	1
-------	----	---

Acero y zamak
Aço e zamak

Perfil pasacables

Perfil passa-cabos

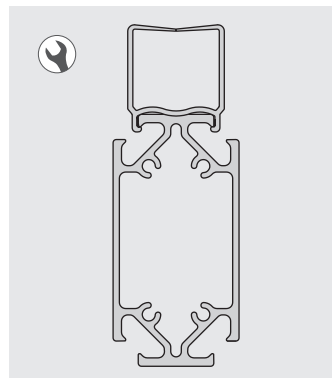
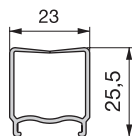

Cod. 



2,3 m	69106	21	20,7 m
-------	-------	----	--------

Plástico / Plástico

INFORMACIÓN / INFORMAÇÃO

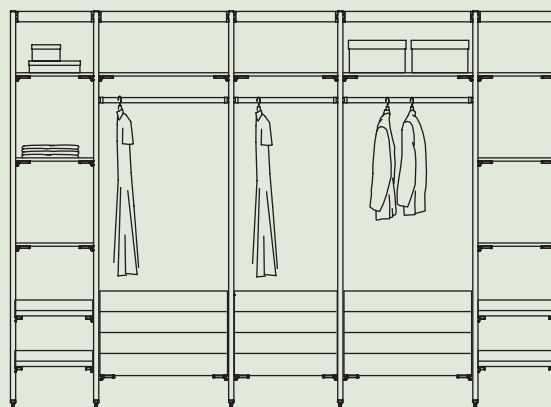
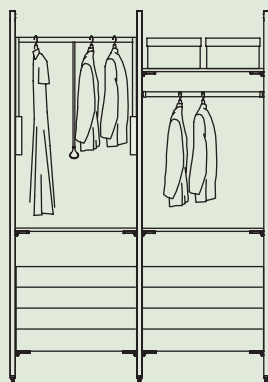
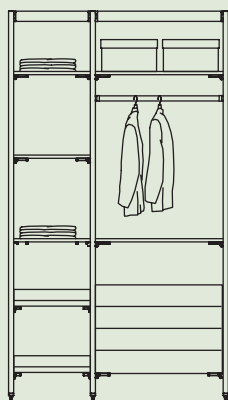
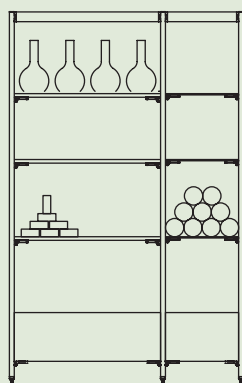
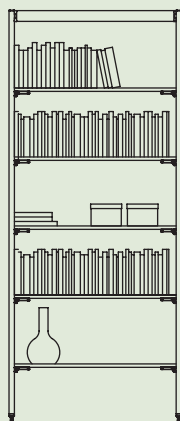
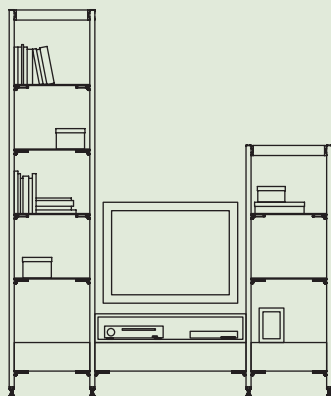
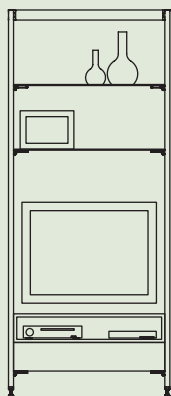

7.61 Información perfiles Plus

Puertas Plus de aluminio

7.62 Perfiles Plus

7.67 Accesorios para perfiles Plus

7.70 Tiradores

PERFIS PARA PORTAS COM MOLDURA DE ALUMÍNIO

7.61 Informação portas alumínio

Portas Plus de alumínio

7.62 Perfis Plus





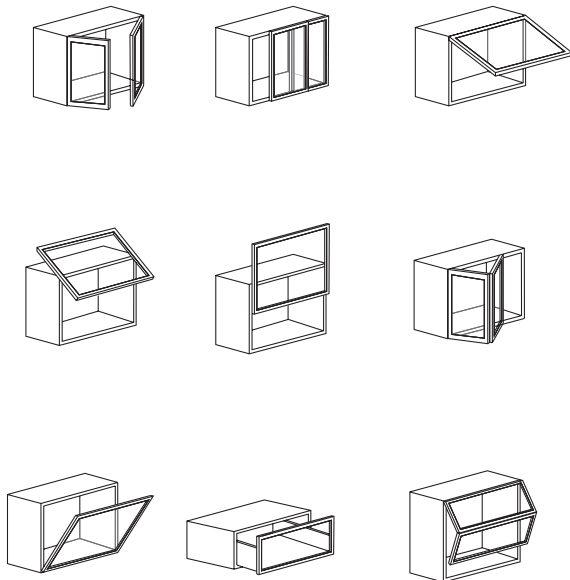



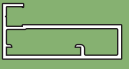
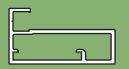

7.67 Acessórios para perfis Plus

7.70 Puxadores

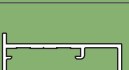
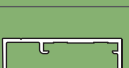



INFORMACIÓN / INFORMAÇÃO

			SISTEMAS CORREDEROS / SISTEMAS DE CORRER						
			ALUROLLER 1	ALUROLLER 2	GLIDER 1	GLIDER 2	TRACK	WIND	WEST 2
PERFILES PLUS / PERFIS PLUS	PLUS 4		✓	✓			✓	✓	✓
	PLUS 4E		✓	✓			✓	✓	✓
	PLUS 7			✓					
	PLUS 10			✓					
	PLUS 11		✓	✓			✓	✓	✓
	PLUS 14		✓	✓			✓	✓	✓
	PLUS 15		✓	✓			✓	✓	✓
	PLUS 16		✓	✓			✓	✓	✓
	PLUS 17		✓	✓	✓	✓	✓	✓	✓
	PLUS 18		✓	✓			✓	✓	✓
	P+T 10			✓					
	P+T 11		✓	✓			✓	✓	✓

PERFILES PLUS

PERFIS PLUS

PLUS 4

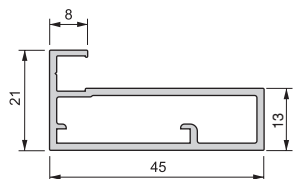

PLUS 4E

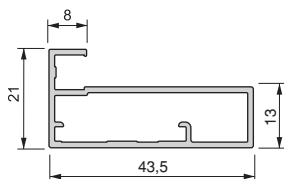

PLUS 7

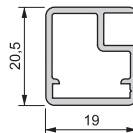

PLUS 10

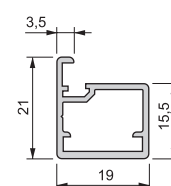

PLUS 11

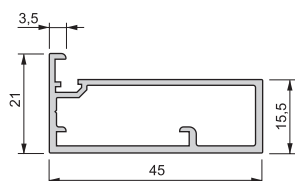

PLUS 14

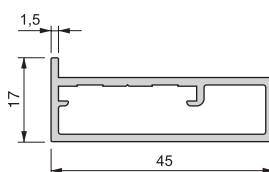

PLUS 15

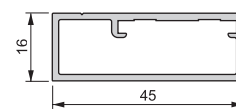

PLUS 16

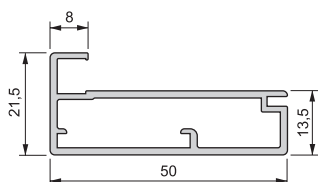

PLUS 17

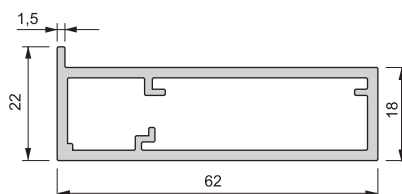

PLUS 18

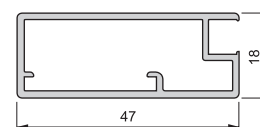

P+T 10

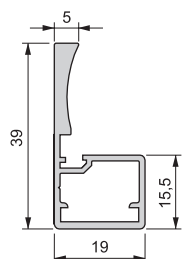

P+T 11

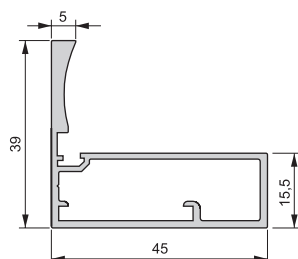

SERVICIO / SERVIÇO



En stock
 Em stock
 En stock listo para servir.
 Em Stock, pronto para entrega.



A medida
 À medida
 Posibilidad de personalizar medida, mecanizado.
 Possibilidade de personalizar a medida, assim como a mecanização.

SIMBOLOGÍA / SIMBOLOGIA



Longitud de barra
 Comprimento de barra



Embalaje
 Embalagem



Posibilidad de chapar
 Possibilidade de revestimento



Adhesivo
 Adesivo



Bisagra cazoleta
 Dobradiça copo



Bisagra para perfil de aluminio
 Dobradiça para perfil de aluminio



Travesaño visto
 Perfil Japonesa visto



Travesaño oculto
 Perfil Japonesa oculto



Montaje vertical y horizontal.
 Montagem vertical e horizontal.



Espesor cristal
 Espessura vidro





















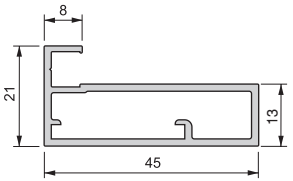

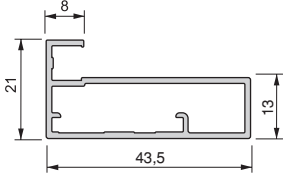
Canto vivo
 Canto vivo

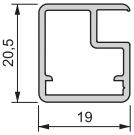

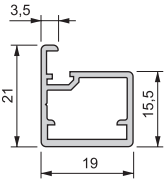

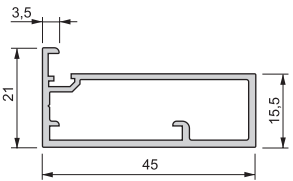

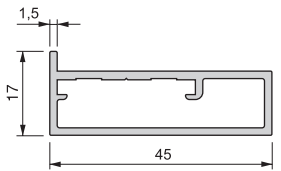



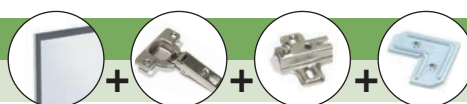

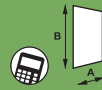





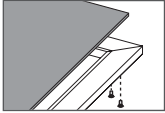





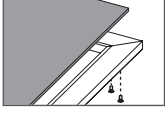





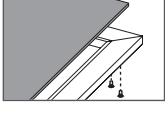





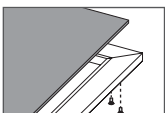

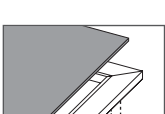

Canto pulido
 Canto polido

PERFILES PLUS

PERFIS PLUS



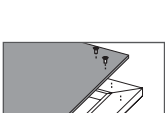













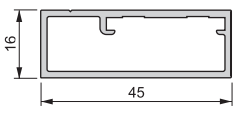

PLUS Croquis / Esboço		 SERVICIO EN STOCK / SERVIÇO EM STOCK						
		Perfil / Perfil			Junquillo / Vedante			
		Cod. 			Cod. 			
PLUS 4		67675 62	4 m	32 m	 60887 21	4 m	80 m	62 
PLUS 4 E		70109 62	4 m	32 m	 60887 21	4 m	80 m	62 
PLUS 7		62958 62	4 m	80 m	 60887 21	4 m	80 m	62 
PLUS 10		69113 62	4 m	80 m	 60654 20	4 m	80 m	60 62 
PLUS 11		69114 62	4 m	32 m	 60654 20	4 m	80 m	14 60 62 69 
		69114 60	2,9 m	23,2 m				
PLUS 14		60004 62	4 m	32 m	 60002 15	m	33 m	62 

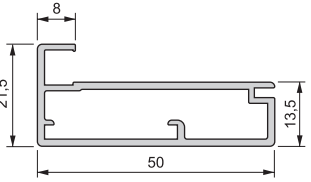

SERVICIO A MEDIDA / SERVIÇO À MEDIDA						DATOS CRISTAL / DADOS VIDRO			
Bisagras Dobradiças	Tirador Puxador	Sistemas correderos Sistemas de correr	Travesaño Perfis H para fazer japonesas			mm	Canto Canto		Posición tornillos Posição parafusos
			Tipo Tipo		Posición Posição				
 Ø35	Tiradores de taladro Puxadores de furo	ALUROLLER 1,2 TRACK WIND WEST 2		62		4		A - 6 B - 6	
	Kanob 1 - 2 Tulip 1 - 2								
 Ø35	Tiradores de taladro Puxadores de furo	ALUROLLER 1,2 TRACK WIND WEST 2		62		4		A - 6 B - 6	
	Kanob 1 - 2 Tulip 1 - 2								
 Ø35	Tiradores de taladro Puxadores de furo	ALUROLLER 2		62		4		A - 27 B - 27	
	Kanob 1 - 2 Tulip 1 - 2								
 Ø35	Tiradores de taladro Puxadores de furo	ALUROLLER 2		62		4		A - 3 B - 3	
	Kanob 1 - 2 Tulip 1 - 2								
 Ø35	Tiradores de taladro Puxadores de furo	ALUROLLER 1,2 TRACK WIND WEST 2		62		4		A - 3 B - 3	
	Kanob 1 - 2 Tulip 1 - 2								
 Ø35	Tiradores de taladro Puxadores de furo	ALUROLLER 1,2 TRACK WIND WEST 2		62		4		A - 4 B - 4	
	Kanob 1 - 2 Tulip 1 - 2								

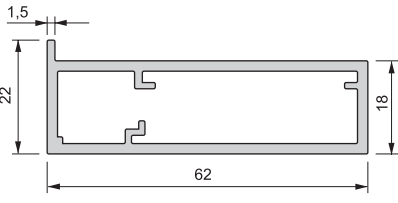
PERFILES PLUS

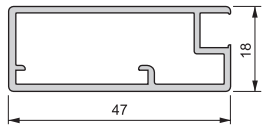

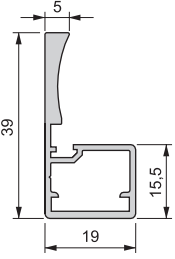
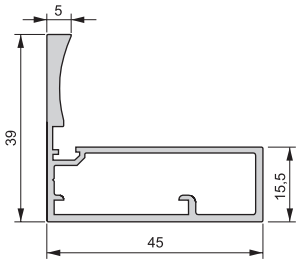

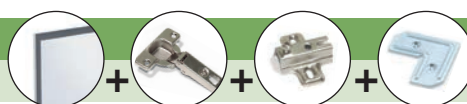







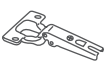



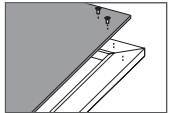
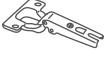



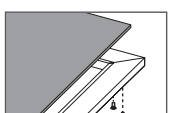

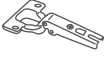



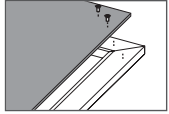
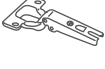

PERFIS PLUS

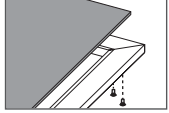
PLUS Croquis / Esboço		 SERVICIO EN STOCK / SERVIÇO EM STOCK						
		Perfil / Perfil			Junquillo / Vedante			
		Cod. 			Cod. 			
PLUS 15		60006 62	4 m	32 m	 60002 15	m	33 m	62 
PLUS 16		60023 62	4 m	32 m	 60887 21	4 m	80 m	62 
					 60022 20		24 m	
PLUS 17		60125 62	4 m	16 m	 60002 15	m	33 m	62 
PLUS 18		60015 62	4 m	32 m	 60887 21	4 m	80 m	62 
P+T 10		X	X	X	X	X	X	62
P+T 11		X	X	X	X	X	X	62

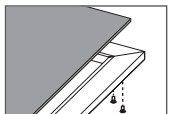
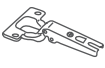

SERVICIO A MEDIDA / SERVIÇO À MEDIDA

DATOS CRISTAL / DADOS VIDRO

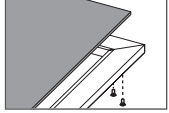
Bisagras Dobradiças	Tirador Puxador	Sistemas correderos Sistemas de correr	Travesaño Perfis H para fazer japonesas			mm	Canto Canto		Posición tornillos Posição parafusos
			Tipo Tipo		Posición Posição				
 Ø35	Tiradores de taladro Puxadores de furo	ALUROLLER 1,2 TRACK WIND WEST 2		62		4		A B	
	Kanob 1 - 2 Tulip 1 - 2								
 Ø35	Tiradores de taladro Puxadores de furo	ALUROLLER 1,2 TRACK WIND WEST 2		62		4		A - 6 B - 6	
	Kanob 1 - 2 Tulip 1 - 2								
 Ø35 Ø40	Tiradores de taladro Puxadores de furo	ALUROLLER 1,2 TRACK WIND WEST 2 GLIDER 1 GLIDER 2		62		4		A - 4 B - 4	
	Kanob 1 - 2 Tulip 1 - 2								
 Ø35	Tiradores de taladro Puxadores de furo	ALUROLLER 1,2 TRACK WIND WEST 2		-		4		A - 84 B - 84	
	Tirador integrado Puxador integrado	ALUROLLER 2		62		4		A - 3 B - 3	
 Ø35	Tirador integrado Puxador integrado	ALUROLLER 1,2 TRACK WIND WEST 2		62		4		A - 3 B - 3	

ACCESORIOS PARA PERFILES PLUS

ACESSÓRIOS PARA PERFIS PLUS

Travesaño para Plus 4 - 4E - 7 - 16

Perfil Japonesa para Plus 4 - 4E - 7 - 16

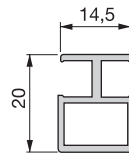

Aluminio / Alumínio

- Acabado anodizado mate.
- Permite dividir la puerta Plus en varios tramos de cristal.
- Posibilidad de colocar el travesaño de forma vertical, horizontal ó en cruz.
- Se fabrica a medida con todos los mecanizados necesarios.
- No pueden coincidir en el mismo punto bisagra y travesaño.

- Acabamento anodizado mate.
- Permite dividir a porta Plus em vários troços de vidro.
- Possibilidade de colocar o perfil Japonesa de forma vertical, horizontal ou em cruz.
- Fabrica-se à medida com todos as mecanizações necessárias.
- Não podem coincidir no mesmo ponto dobradiça e perfil Japonesa.

Travesaño oculto Plus

Perfil Japonesa oculto Plus

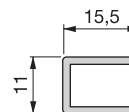

Aluminio / Alumínio

- Acabado anodizado mate.
- Travesaño oculto para puertas Plus 4, 4E, 7, 10, 11, 14, 15, 16 y 17.
- Posibilidad de colocar el travesaño de forma vertical, horizontal ó en cruz.
- Permite reforzar la puerta Plus sin dividir el cristal en tramos.
- Se fabrica a medida con todos los mecanizados necesarios.
- No pueden coincidir en un mismo punto bisagra y travesaño.

- Acabamento anodizado mate.
- Perfil Japonesa oculto para portas Plus 4, 4E, 7, 10, 11, 14, 15, 16 e 17.
- Possibilidade de colocar o perfil Japonesa de forma vertical, horizontal ou em cruz.
- Permite reforçar a porta Plus sem necessidade de dividir o vidro em troços.
- Fabrica-se à medida com todos as mecanizações necessárias.
- Não podem coincidir no mesmo ponto dobradiça e perfil Japonesa.

Bolsa de herrajes para un travesaño

Saco de ferragens para um perfil Japonesa



Cod.

62518 20 1

Acero y Zamak
Aço e Zamak



CÁLCULO DE MEDIDA PARA CRISTALES DE PUERTAS CON TRAVESAÑO
 CÁLCULO DE MEDIDA PARA VIDROS DE PORTAS COM PERFIL JAPONESA

Plus	B
4 - 16	6 mm
7	27 mm
10 - 11	3 mm

$$\text{Altura} = \frac{H - B - (nT \times 3)}{nT + 1}$$

$$\text{Ancho} = \frac{A - B - (nV \times 3)}{nV + 1}$$



H = Altura.
 nT = Número de travesaños horizontales.
 A = Anchura.
 nV = Número de travesaños Verticales.

H = Altura.
 nT = Número de perfis Japonesa s horizontais.
 A = Largura.
 nV = Número de perfis Japonesa s verticais

Junquillo para Plus 4 - 4E - 7 - 16 - 18

Vedante para Plus 4 - 4E - 7 - 16 - 18





	Cod. 	
4 m	60887 21	80 m
Plástico / Plástico		

Junquillo para Plus 10 - 11

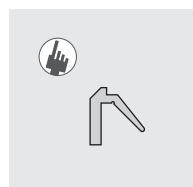
Vedante para Plus 10 - 11





	Cod. 	
4 m	60654 20	80 m
Plástico / Plástico		

Cinta adhesiva doble cara para cristal

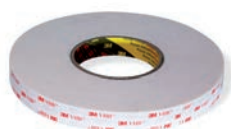
Fita adesiva de dupla face para vidro





Cod. 	
60002 15	24 m
Plástico / Plástico	

Perfil tope para cristal estanco Plus 16

Perfil batente para vidro estanque Plus 16





Cod. 	
60022 20	24 m
Plástico / Plástico	

Espaciador para tirador

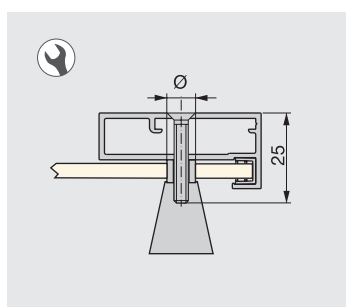
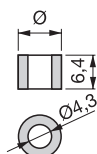
Espaçador para puxador



Ø	Cod. 	
7,9	62273 20	20
6,4	69185 20	20

- Indicado para Plus 4, 4E, 11, 14, 15, 16 y 17.
- Indicado para Plus 4, 4E, 11, 14, 15, 16 e 17.

Escuadras y bisagras Plus 7 - 10

Esquadros e dobradiças Plus 7 - 10

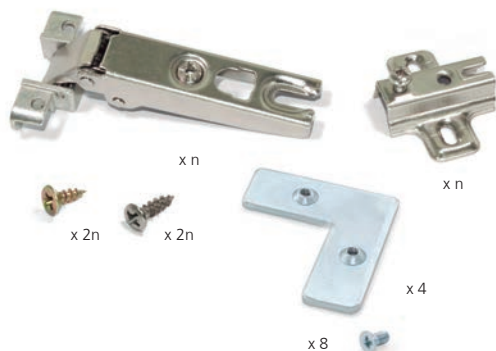

n	Cod.		
0	99847	20	1
2	98299	20	1
3	98300	20	1
4	98301	20	1

- Bisagra C95 recta para perfiles de aluminio Cod. 12451 07 y suplemento altura 2 Cod.12382 07.
- n = número de bisagras y suplementos.

- Dobradiça C95 recta para perfil de aluminio Cod. 12451 07 e calço altura 2 Cod.12382 07.
- n = número de dobradiças e calços.

Escuadras y bisagras Plus 4 - 4E - 11 - 14 - 15 - 16 - 18

Esquadros e dobradiças Plus 4 - 4E - 11 - 14 - 15 - 16 - 18

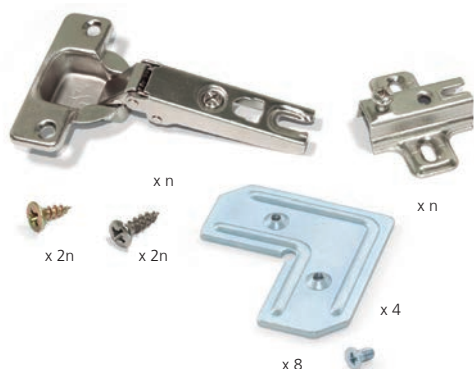

n	Cod.		
0	99855	20	1
2	98348	20	1
3	98349	20	1
4	98350	20	1

- Bisagra C95 de cazoleta Ø35 Cod. 12361 07 y suplemento altura 2 Cod. 12382 07.
- n = número de bisagras y suplementos.

- Dobradiça C95 de copo Ø35 Cod. 12361 07 e calço altura 2 Cod. 12382 07.
- n = número de dobradiças e calços.



COTA MÍNIMA DE MECANIZADO DE LA BISAGRA EN PERFILES PLUS
 COTA MÍNIMA DE MECANIZAÇÃO DA DOBRADIÇA EM PERFIS PLUS

Plus	Escuadra normal Esquadro normal	Escuadra recortada Esquadro recortado
7 - 10	69 mm	60 mm
4 - 4E - 11 - 16 - 18	86 mm	78 mm
14 - 15	78 mm	70 mm
17	60 mm	-

Escuadras Plus 17

Esquadros Plus 17



Cod.		
60126	01	1

Aluminio / Alumínio



TIRADORES

PUXADORES

Kanob 1

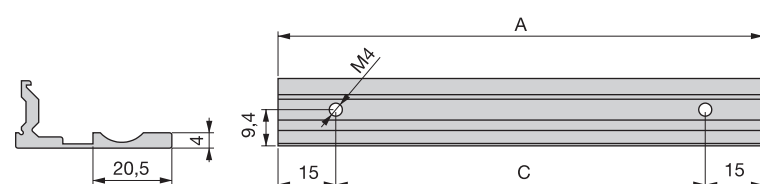
Kanob 1



A	C	Cod.		
94	64	69101	62	20
126	96	69100	62	20

Aluminio / Alumínio

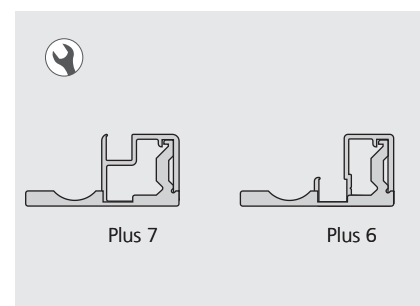



- Son tiradores para perfiles de aluminio Plus 4, 4E, 7, 10, 11, 14, 16 y 17.
- Se incluyen tornillos de M4x10mm para su montaje.
- Están atornillados por la parte trasera de la puerta, por lo que no se ven los tornillos ni por delante ni por el lateral de la puerta.
- Requiere mecanización en la puerta de aluminio.

- São puxadores para perfis de alumínio Plus 4, 4E, 7, 10, 11, 14, 16 e 17.
- Incluem-se os parafusos M4x10mm para a sua montagem.
- São aparafusados pela parte posterior da porta, pelo que os parafusos não ficam visíveis nem pela parte da frente nem pelo lateral da porta.
- Requer mecanização na porta de alumínio.

Kanob 2

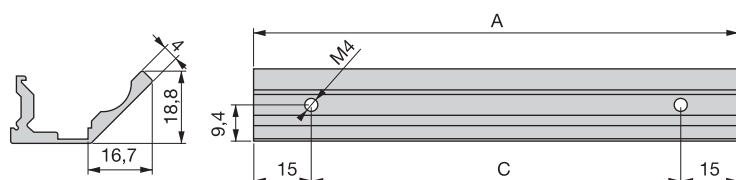
Kanob 2



A	C	Cod.		
94	64	69104	62	20
126	96	69103	62	20

Aluminio / Alumínio

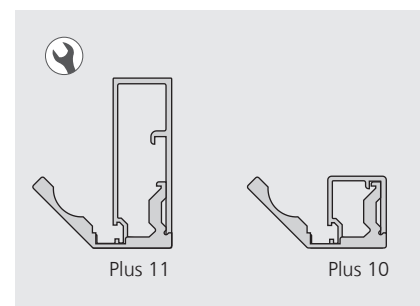

- Son tiradores para perfiles de aluminio Plus 4, 4E, 7, 10, 11, 14, 16 y 17.
- Se incluyen tornillos de M4x10mm para su montaje.
- Están atornillados por la parte trasera de la puerta, por lo que no se ven los tornillos ni por delante ni por el lateral de la puerta.
- Requiere mecanización en la puerta de aluminio.

- São puxadores para perfis de alumínio Plus 4, 4E, 7, 10, 11, 14, 16 e 17.
- Incluem-se os parafusos M4x10mm para a sua montagem.
- São aparafusados pela parte posterior da porta, pelo que os parafusos não ficam visíveis nem pela parte da frente nem pelo lateral da porta.
- Requer mecanização na porta de alumínio.

Tulip 1

Tulip 1

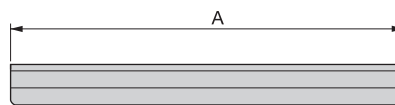
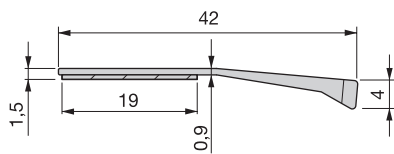

- No es necesario mecanizar para su instalación.
- Para espesores de 19mm como mínimo.

- Não é necessário mecanizar para a sua instalação.
- Para espessura mínima de 19mm.

A	Cod.			
62	69202	-	62	20
94	69203	-	62	20
126	69204	-	62	20
158	69205	<u>60</u>	62	20

Aluminio / Alumínio

Tulip 2

Tulip 2

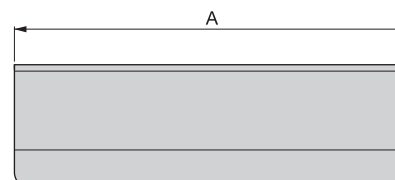
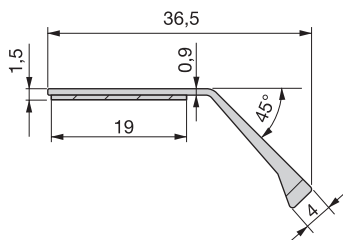

- No es necesario mecanizar para su instalación.
- Para espesores de 19mm como mínimo.

- Não é necessário mecanizar para a sua instalação.
- Para espessura mínima de 19mm.

A	Cod.			
62	69206	-	62	20
94	69207	-	62	20
126	69208	-	62	20
158	69209	60	62	20

Aluminio / Alumínio



